



H25-IR

Infrared Refrigerant Gas Leak Detector

Instruction 3015-4342

Operation & Maintenance

Rev. 5 – March 2009

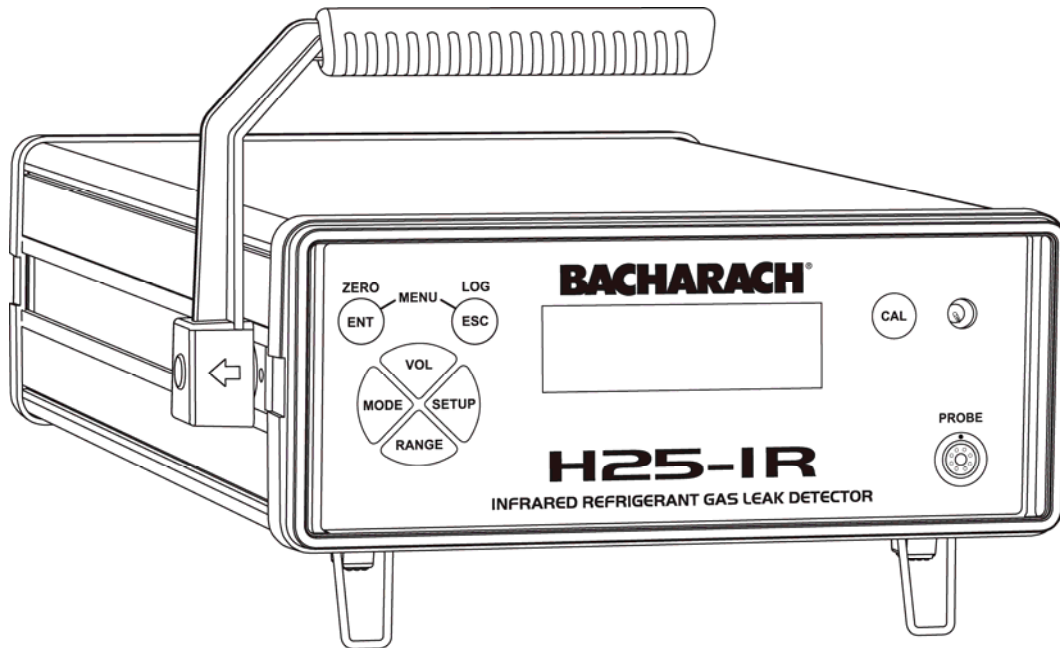

WARRANTY

Bacharach, Inc. warrants to Buyer that at the time of delivery this Product will be free from defects in material and manufacture and will conform substantially to Bacharach Inc.'s applicable specifications. Bacharach's liability and Buyer's remedy under this warranty are limited to the repair or replacement, at Bacharach's option, of this Product or parts thereof returned to Seller at the factory of manufacture and shown to Bacharach Inc.'s reasonable satisfaction to have been defective; provided that written notice of the defect shall have been given by Buyer to Bacharach Inc. within two (2) years after the date of delivery of this Product by Bacharach, Inc.

Bacharach, Inc. warrants to Buyer that it will convey good title to this Product. Bacharach's liability and Buyer's remedy under this warranty of title are limited to the removal of any title defects or, at the election of Bacharach, to the replacement of this Product or parts thereof that are defective in title.

The warranty set forth in paragraph 1 does not apply to parts the Operating Instructions designate as having a limited shelf-life or as being expended in normal use (e.g., filters).

THE FOREGOING WARRANTIES ARE EXCLUSIVE AND ARE GIVEN AND ACCEPTED IN LIEU OF (I) ANY AND ALL OTHER WARRANTIES, EXPRESS OR IMPLIED, INCLUDING WITHOUT LIMITATION THE IMPLIED WARRANTIES OF MERCHANTABILITY AND FITNESS FOR A PARTICULAR PURPOSE; AND (II) ANY OBLIGATION, LIABILITY, RIGHT, CLAIM OR REMEDY IN CONTRACT OR TORT, WHETHER OR NOT ARISING FROM BACHARACH'S NEGLIGENCE, ACTUAL OR IMPLIED. The remedies of the Buyer shall be limited to those provided herein to the exclusion of any and all other remedies including, without limitation incidental or consequential damages. No agreement varying or extending the foregoing warranties, remedies or this limitation will be binding upon Bacharach, Inc. unless in writing, signed by a duly authorized officer of Bacharach.

**Register your warranty by visiting
www.bacharach-inc.com**

Notice:

Product improvements and enhancements are continuous; therefore the specifications and information contained in this document may change without notice.

Bacharach, Inc. shall not be liable for errors contained herein or for incidental or consequential damages in connection with the furnishing, performance, or use of this material.

No part of this document may be photocopied, reproduced, or translated to another language without the prior written consent of Bacharach, Inc.

Copyright © 2005–2009, Bacharach, Inc., all rights reserved.

BACHARACH® is a registered trademark of Bacharach, Inc. All other trademarks, trade names, service marks and logos referenced herein belong to their respective owners.

Table of Contents

1	Introduction	1
1.1	Purpose of Instruction Manual	1
1.2	Safety Precautions	1
1.2.1	Warning Statements	1
1.2.2	Caution Statements	1
1.2.3	Hazard Symbols	1
1.2.4	AC Power and Grounding	1
1.2.5	Explosive Atmosphere	2
1.2.6	Accessing the Interior of the Instrument	2
1.2.7	Misuse and Modifications to Instrument	2
1.2.8	In Case of Malfunction	2
1.2.9	Cleaning	2
1.3	Ordering Information	3
1.4	Unpacking and Initial Checks	3
1.5	Features and Capabilities	4
1.6	Functional Overview	5
1.7	Names and Functions of Components	6
1.7.1	Front View	6
1.7.2	Rear View	7
1.7.3	Interior	7
1.7.4	Standard Probe	8
1.7.5	Standard Probe with LED and Programmable Pushbutton	8
1.7.6	Smart Probe	9
1.7.7	Smart Probe Keylock Function	9
1.8	Menu System	9
2	Preparing for Operation	11
2.1	Connecting the Probe	11
2.2	Connecting the AC Power Cord	11
2.3	Battery Pack	11
2.4	Turning ON the Instrument	11
2.5	System Setup	12
2.5.1	Gas Type	12
2.5.2	Leak Units	12
2.5.3	Relays	13
2.5.4	4–20 mA Loop	13
2.5.5	Brightness	14
2.5.6	Clock	14
2.5.7	PCHK Mode	14
2.5.8	Probe Button	14
2.5.9	Reset Defaults	14
2.6	Configuring the SETUPS Function	15
2.6.1	Setup Name	15
2.6.2	Range	15
2.6.3	Gas Type	16
2.6.4	Feedback Mode	16
2.6.5	Setpoint	16
2.6.6	Search Auto Zero	17
2.7	External Relay Connections	18
2.8	4–20 mA Current Loop Connection	19
3	Calibration	21
3.1	Selecting Internal or External Calibration	21
3.1.1	Internal Calibration Selection	21
3.1.2	External Calibration Selection and Setup	22
3.2	Internal Calibration	22
3.3	External Calibration	23
3.4	CAL Factor	24
3.4.1	Simulating Other Internal Leak Source Gas Types Using the CAL Factor	25
3.4.2	Improving PPM Measurement Accuracy using the CAL Factor	25
3.4.3	Adjusting the CAL Factor	26

- 3.5 Restoring Factory Calibration 27
- 3.6 Storing a New Factory Calibration 27
- 4 Operation 29**
 - 4.1 Instrument Location 29
 - 4.2 Using the H25-IR 29
 - 4.2.1 Power 29
 - 4.2.2 Initial Setup 29
 - 4.2.3 Range Selection 30
 - 4.2.4 Setup Selection 30
 - 4.2.5 Volume Adjustment 30
 - 4.2.6 Searching for a Leak 31
 - 4.2.7 Measuring the Leak Rate 31
 - 4.2.8 Measuring the PPM Level 32
 - 4.2.9 Logging Measured Readings 32
 - 4.2.10 Logged Measurements 33
 - 4.2.10.1 Viewing Logged Measurements 33
 - 4.2.10.2 Clearing the Log 33
 - 4.2.10.3 Viewing the Total of All Logged Measurements 33
 - 4.2.10.4 Setting the Log Limit 34
 - 4.3 Fault Conditions 34
 - 4.4 PCHK (atmospheric Pressure CHeck) 35
 - 4.5 RS-232 Communication 35
 - 4.6 Serial Output Types 35
- 5 Maintenance 37**
 - 5.1 Diagnostics Menu 37
 - 5.1.1 Sensor Data 37
 - 5.1.2 Last Fault 38
 - 5.1.3 IR Emitter 39
 - 5.1.4 Pressure 39
 - 5.1.5 Loop Test 39
 - 5.1.6 Clear Last Fault 39
 - 5.1.7 Auto Gain 40
 - 5.2 Factory Menu 40
 - 5.2.1 DIGIPOT 40
 - 5.2.2 Leak Rate 40
 - 5.2.3 Leak Gas 41
 - 5.2.4 Leak Temp 41
 - 5.2.5 Leak TEMPCO 41
 - 5.2.6 Sensor Cal 41
 - 5.2.6.1 Pressure Sensor Calibration Screen 41
 - 5.2.6.2 Flow Rate Sensor Calibration Screen (Factory Calibration) 42
 - 5.2.6.3 Box Temperature Calibration Screen 42
 - 5.2.7 Model Select 42
 - 5.2.8 Probe Type 43
 - 5.2.9 Firmware 43
 - 5.3 Flashing Memory 43
 - 5.4 Part Replacement 46
 - 5.4.1 Removing the Top Cover 46
 - 5.4.2 Fuse Replacement 47
 - 5.4.3 Probe Tip Filter & O-Ring Replacement 47
 - 5.4.4 Sprint Switch Replacement 48
 - 5.4.5 Internal Filter Replacement 49
 - 5.4.6 Optical Bench Replacement 49
 - 5.4.6.1 Top Cover Removal 50
 - 5.4.6.2 Installing the New IR Optical Bench 50
 - 5.4.6.3 IR Emitter Adjustment 50
 - 5.4.6.4 DIGIPOT Adjustment 51
 - 5.4.6.5 Factory Calibration 51
 - 5.5 Replacement Parts 53
 - 5.6 Service Centers 54

6	Troubleshooting.....	55
7	Specifications.....	61
	APPENDIX A – Factory Defaults.....	63

Notes:

1 Introduction

1.1 Purpose of Instruction Manual

This instruction manual provides important information on how to install, operate, and service the Bacharach H25-IR Refrigerant Gas Leak Detector.

To assure operator safety and the proper use of this instrument, please *read, understand, and follow* the contents of this manual.

Please retain these instructions for future reference.

1.2 Safety Precautions

Safety is essential in the use and maintenance of Bacharach equipment. Therefore this instruction manual and any markings on the exterior of H25-IR case provide important safety information concerning the operation and maintenance of this instrument.

1.2.1 Warning Statements

The use of the word **WARNING** in this manual denotes a potential hazard associated with the use of this equipment. It calls attention to a procedure, practice, condition, or the like, which if not correctly performed or adhered to, could result in injury or death of personnel using this instrument.

1.2.2 Caution Statements

The use of the word **CAUTION** in this manual denotes a potential hazard associated with the use of this equipment. It calls attention to a procedure, practice, condition, or the like, which if not correctly performed or adhered to, could result in damage to the instrument.

1.2.3 Hazard Symbols



This symbol indicates the need to consult this instruction manual when opening the enclosure.
WARNING: A potential risk exists if the operating instructions are not followed.



This symbol indicates the presence of electric shock hazards when the enclosure is opened.
WARNING: To avoid risk of injury from electric shock, do not open the enclosure when AC power is applied to the instrument.

1.2.4 AC Power and Grounding

The H25-IR uses a universal power supply that is capable of accepting inputs of 100 to 240 VAC, 50/60 Hz.

Under no circumstances should this instrument be operated without connection to a protective ground. Doing so creates a potential shock hazard and is also a violation of electrical safety standards applicable to this type of equipment.

1.2.5 Explosive Atmosphere

Do not operate this instrument in the presence of flammable liquids, vapors or aerosols. Operation of any electrical instrument in such an environment constitutes a safety hazard.

1.2.6 Accessing the Interior of the Instrument

Only qualified maintenance personnel should access the interior of this instrument. Always unplug the AC power cord before performing any wiring or maintenance work.

1.2.7 Misuse and Modifications to Instrument

The operation of the H25-IR may be impaired if the instrument is used in a manner not specified in this instruction manual. Changes or modifications to the instrument, not expressly approved by Bacharach, will void the warranty.

1.2.8 In Case of Malfunction

Do not continue to use this equipment if there are any symptoms of malfunction or failure. In the case of such occurrence, unplug the AC power cord and contact a qualified repair technician or the nearest Bacharach Service Center.

1.2.9 Cleaning

USE a dry cloth to clean the outside of the case. **DO NOT** use soap and water.

1.3 Ordering Information

The H25-IR instrument along with its Probe type and Hose length are ordered by specifying 3 codes. The codes must be listed in the following sequence:

Code A – Model Name

Code B – Gas Type

Code C – Probe Type and Hose Length

Table 1-1. H25-IR Instrument, Probe Type & Hose Length Ordering Information

	Code	Description
Code A	H25IR	Infrared Gas Leak Detector
Code B	-1	CFC, HFC, HCFC & Halogen Gases
	-2	R600a
	-3	SF ₆
	-4	CO ₂
	-5	R227
Code C	-1	Standard Probe, 6 foot Hose
	-2	Standard Probe, 12 foot Hose
	-3	Standard Probe, LED & Button, 6 foot Hose
	-4	Standard Probe, LED & Button, 12 foot Hose
	-5	Smart Probe, 6 foot Hose
	-6	Smart Probe, 12 foot Hose

For example: To order an H25-IR that detects CFC type refrigerants; a Standard Probe with LED & Button; and a 6 foot hose, you would order an **H25IR-1-3**

1.4 Unpacking and Initial Checks

Your H25-IR Refrigerant Gas Leak Detector and all accessories were carefully inspected at the factory before shipment, and packed so as to be highly resistant to damage while in transport.

When you receive the instrument, please unpack it promptly and make a visual inspection to make sure that no damage has occurred during shipment and that all ordered items have been received. Your order should consist of:

- H25-IR instrument
- Probe and Hose Assembly
- Both an 8 and 15 inch Flexible Probe Tube
- AC Power Cord or Battery (dependent on model type)
- Instruction Manual.
- Carrying case (with battery powered units)

If damage was found, immediately file a claim with the carrier. If an item is missing, please contact Bacharach's Service Department for assistance (refer to Section 5.6 *Service Centers*).

1.5 Features and Capabilities

- Detects and measures (depending on instrument's part number):
 - CFCs, HCFCs, HFCs and halogens
 - R600a
 - SF₆
 - CO₂
 - R227
- Infrared detector
- Internal calibration leak standard
- Provision for external calibration on other types of gases
- User selectable leak rate measurement in either Oz/yr, g/yr, mL/s, PaM³/s, or ppm
- Easy to read Vacuum Fluorescent Display (VFD)
- Excellent background gas rejection
- 4–20 mA current loop output
- Relay outputs for external equipment control
- On screen menu system for system setup, diagnostics, calibration, and data logging
- Assortment of probe and hose assemblies, available in either 6 or 12 foot (1.8 or 3.7 m) hose lengths
- Assortment of flexible probe tubes, available in either 8 or 15 inch (200 or 381 mm) lengths

1.6 Functional Overview

The H25-IR is an industrial gas leak analyzer for the detection of CFCs, HCFCs, HFCs and halogen gas compounds, R600a, SF₆, CO₂ or R227. This instrument can be used to locate and then quantify gas leaks, as well as log and totalize a group of leaks in a system.

The H25-IR's front panel contains 7 membrane pushbuttons, probe connector, calibration gas port, and a 3-¼ x ¾ inch VFD (Vacuum Fluorescent Display) that provides a bright, high-contrast display for easy viewing. The plug-in instrument is housed in an all-metal case with adjustable handle. The battery operated instrument version includes a padded carrying case.

The instrument has two modes of operation: **Search** and **Measure**. The Search mode is used to locate the source of a leak. While the Measure mode is used to quantify the size of the leak. A hand-held probe is used to draw in a gas sample from the area under inspection.

With the instrument in its Search mode, the location of a leak is pinpointed by means of visual and audio indicators positioned on both the instrument and probe*. As the probe tip approaches the leak source the length of a bar graph at the bottom of the instrument's front panel display, the blink rate of an LED on the probe, and the frequency of an audible tone are all affected in a positive manner (bar graph becomes longer, LED flashes faster, and the audio tone increases in frequency). There are three search sensitivities available: SM, MED and LG, indicating the size of the leak being searched for. This feature is useful in avoiding being bothered with small leaks when searching for larger ones.

In the Measure mode, the probe tip is held over the leak source until the displayed value of the leak rate stabilizes. Leak rates can be displayed in units of Oz/yr, g/yr, mL/s, PaM³/s. The Measure mode can also be used to display the quantity of gas contained in a confined space with the instrument set up in its ppm mode.

The leak rate is measured by first capturing all the gas leaking from the component under test. Then by accurately measuring the flow rate of the sampling stream and the gas concentration within that stream, the leak rate can be calculated using Equation 1-1. The instrument then converts this data into the desired leak rate units of measure and displays the leak rate on the instrument's front panel.

Eq. 1-1

Leak Rate = Flow Rate x Gas Concentration

where:

Leak Rate = rate of gas leak from component under test

Flow Rate = sample flow rate

Gas Concentration = concentration of gas in the sample (ppm)

A leak measurement can be logged in memory with a time/date stamp. Up to 50 leaks can be logged and totalized. This feature is useful in testing an installation that has a maximum permissible leak rate. Logged data can be recalled for viewing on the display.

There are four user-defined setups that allow the operator to quickly switch between frequently used combinations of Gas Type, Range, Feedback Mode, Setpoint, and the Auto Zero Off condition.

Extensive diagnostics keep track of several system parameters. When a fault is detected, the word "FAULT" blinks on the display and an audible beep is heard every 2 seconds. Text descriptions of all current fault conditions can be displayed from the instrument's Diagnostics menu.

Four SPDT relays provide control over a variety of external equipment (e.g., horns, bells, strobe lights) that can be automatically triggered when their associated relays are energized by any one of 11 different operating conditions.

A 4–20 mA current loop output can be used for the connection of external monitoring equipment (e.g., chart recorder). An RS232 serial port can output leak rate data as ASCII text at 10 times per second.

* The Standard Probe does not contain an LED.

1.7 Names and Functions of Components

1.7.1 Front View

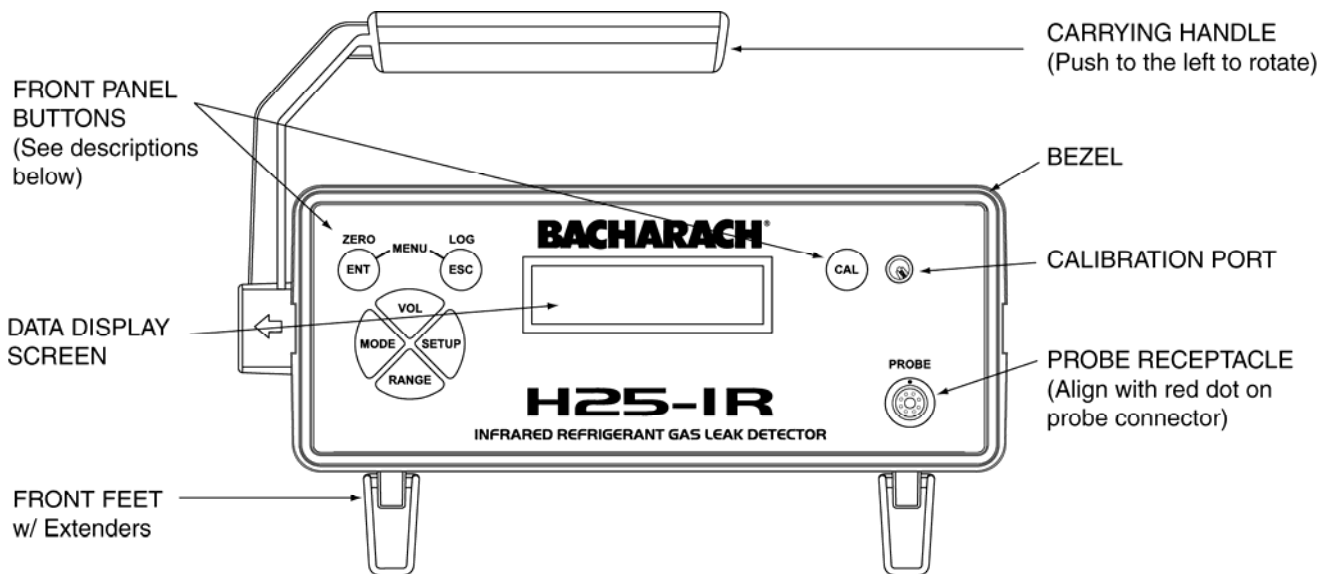

Front Panel Buttons

ENT (Enter)	<ul style="list-style-type: none"> Selects a highlighted menu item. Saves a selection or manually entered data (e.g. date and time).
ESC (Escape)	<ul style="list-style-type: none"> Displays a previously viewed menu or data screen. Cancels a data entry function; retains old data; and displays previous screen.
VOL (Volume)	Volume adjustment. The Up and Down buttons slowly raise and lower the volume; the Left button sets volume to minimum; and the Right button set volume to maximum.
SETUP	Selects one of four user-defined setups consisting of: Range, Gas Type, Feedback Mode, and the Auto Zero OFF condition.
MODE	Toggles the operating mode between Search and Measure.
RANGE	Selects one of three sensitivity ranges (small, medium, or large leak).
ZERO	Zeros the gas reading.
LOG	Logs the currently displayed gas measurement in memory when in the Measure mode, where it can later be reviewed using the Main menu's LOG function.
MENU	Press both the ENT and ESC buttons at the same time to display the Main menu.
CAL (Calibration)	Starts the calibration process where the instrument is calibrated to a known leak source using either the instrument's front panel Calibration Port, or a customer supplied external leak source.
	<p>Menu selection and data entry buttons:</p> <p>Up – Moves selected (highlighted) menu item up through screen, or increments an alphanumerical value when entering data.</p> <p>Down – Moves selected (highlighted) menu item down through screen, or decrements an alphanumerical value when entering data.</p> <p>Left – Moves cursor left across screen.</p> <p>Right – Moves cursor right across screen.</p>

1.7.2 Rear View

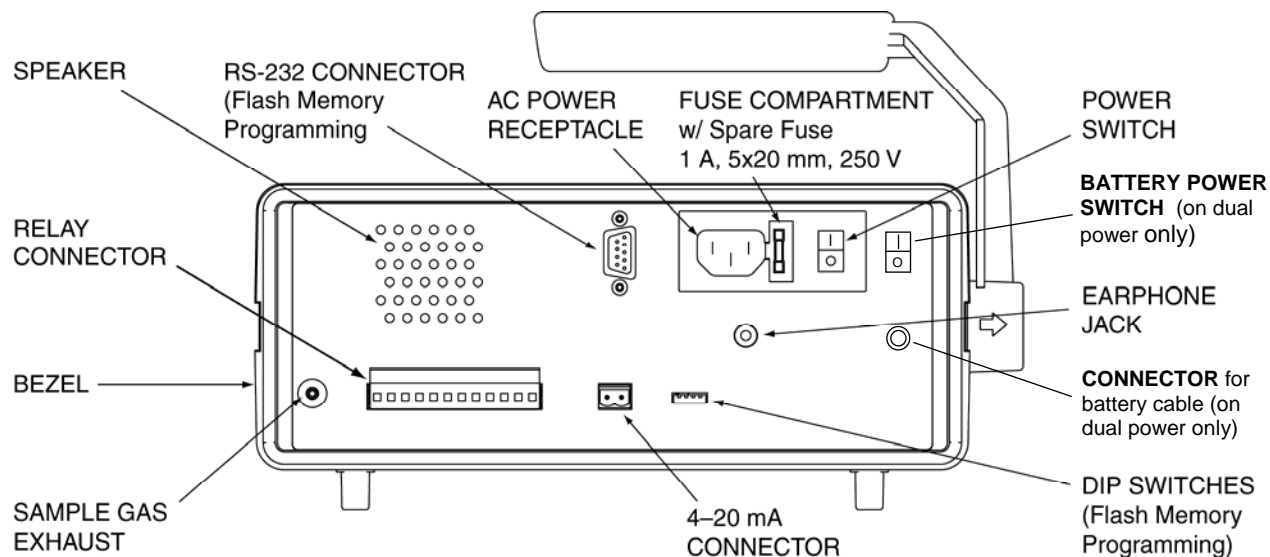

1.7.3 Interior

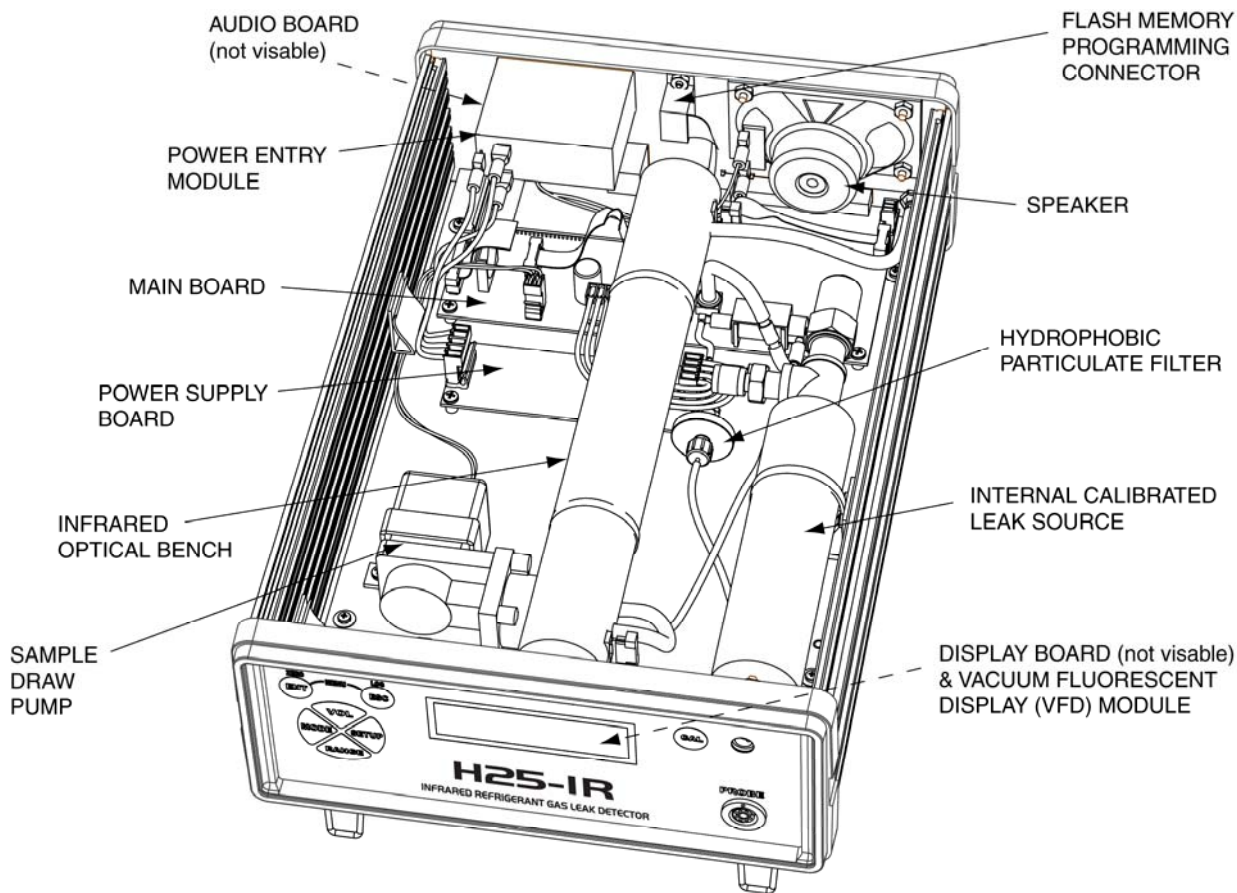

1.7.4 Standard Probe

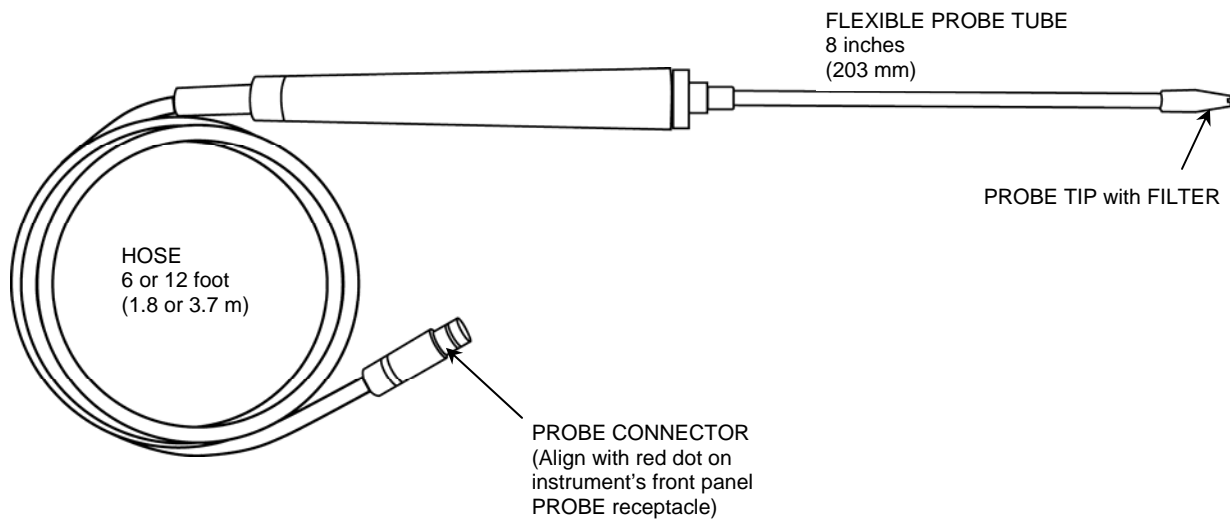

1.7.5 Standard Probe with LED and Programmable Pushbutton

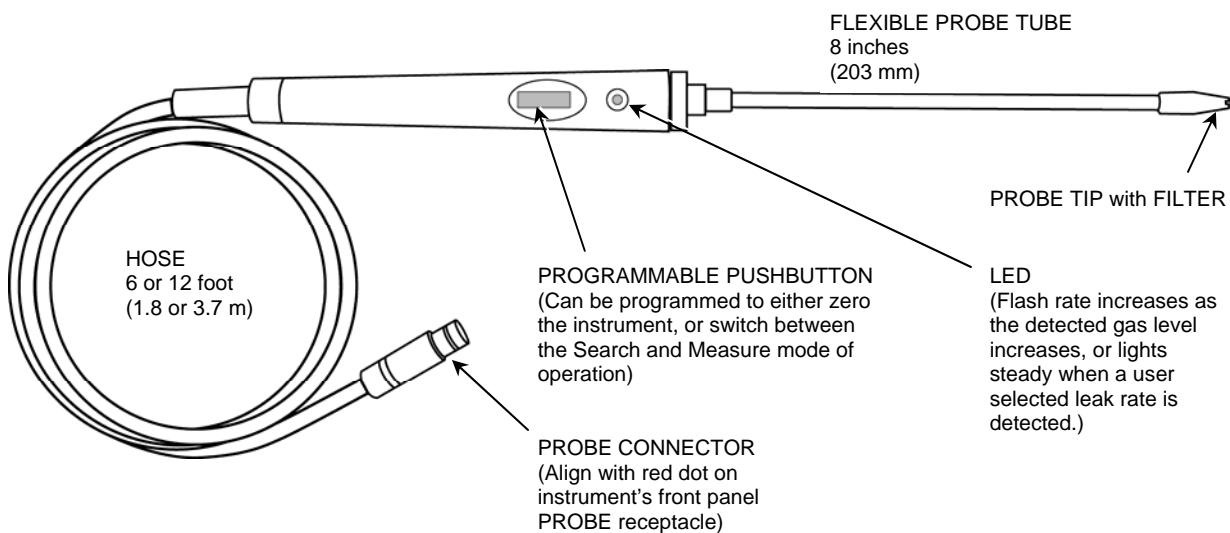

1.7.6 Smart Probe

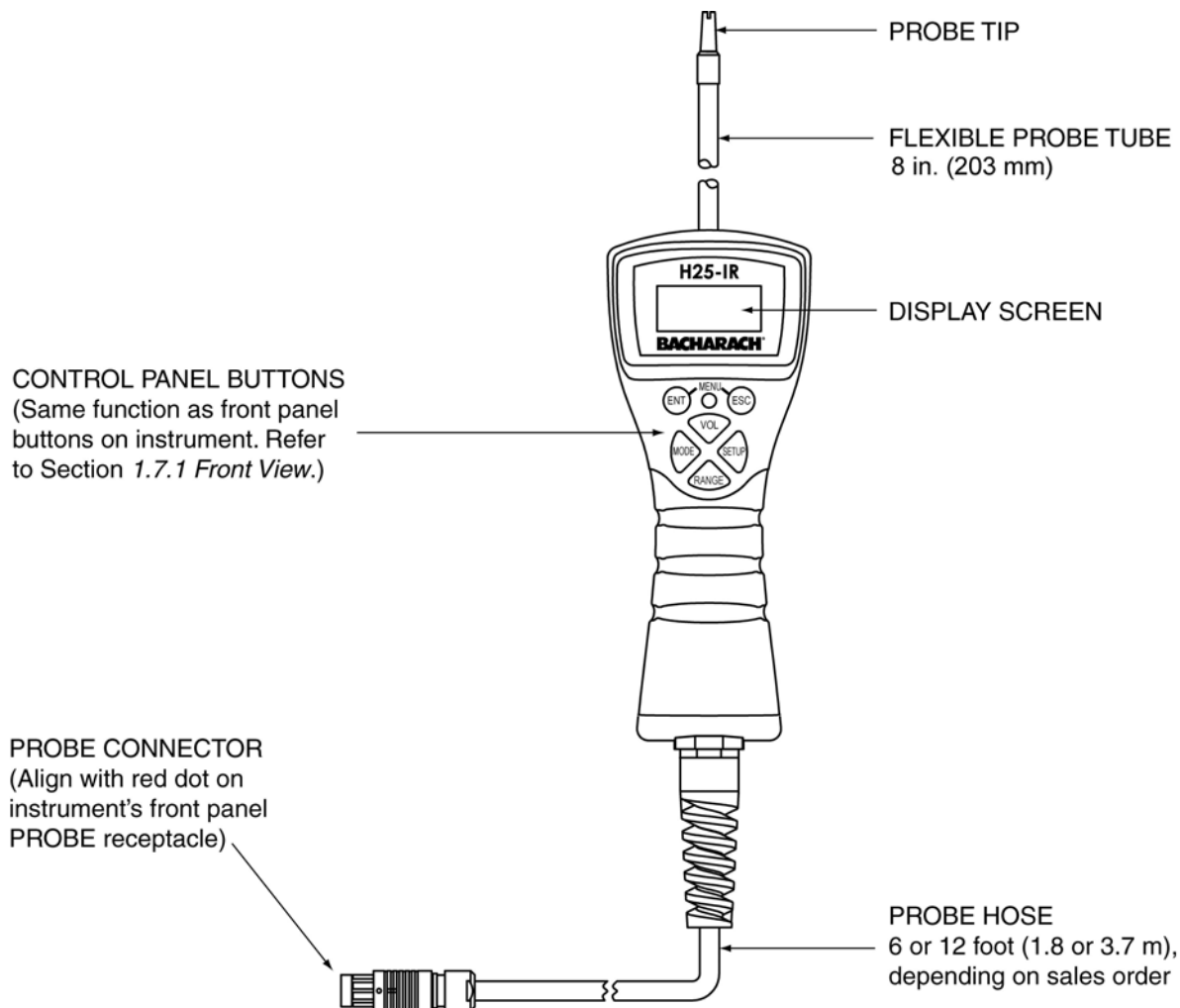

1.7.7 Smart Probe Keylock Function

The Smart Probe's keypad can be locked to prevent accidental key presses when working in tight spaces.

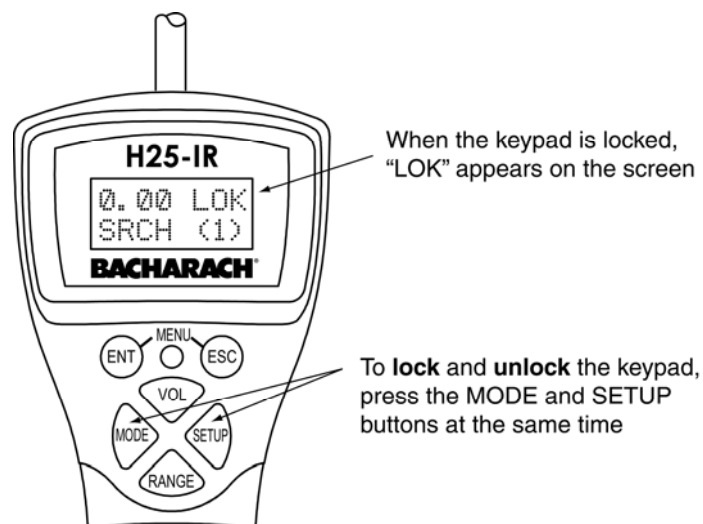

1.8 Menu System

Press the **ENT** and **ESC** keys at the same time to access the Main menu.

The menu system enables the operator to perform such functions as setting up the instrument, viewing logged readings, configuring the four user-defined setups, entering calibration data, and viewing the instrument's diagnostic readings.

The buttons on the instrument's front panel and probe are mapped the same and can be used inter-changeably, with exception of the **CAL** button.

Select a menu item by first using the **Up** and **Down** buttons to highlight the desired item, and then pressing **ENT** to select that item and display its data screen. After an item has been selected, use the **Left**, **Right**, **Up**, and **Down** buttons to highlight or change data within a screen. Pressing the **ENT** button saves the new data, while pressing the **ESC** button aborts the operation and displays the previous screen.

Main Menu:

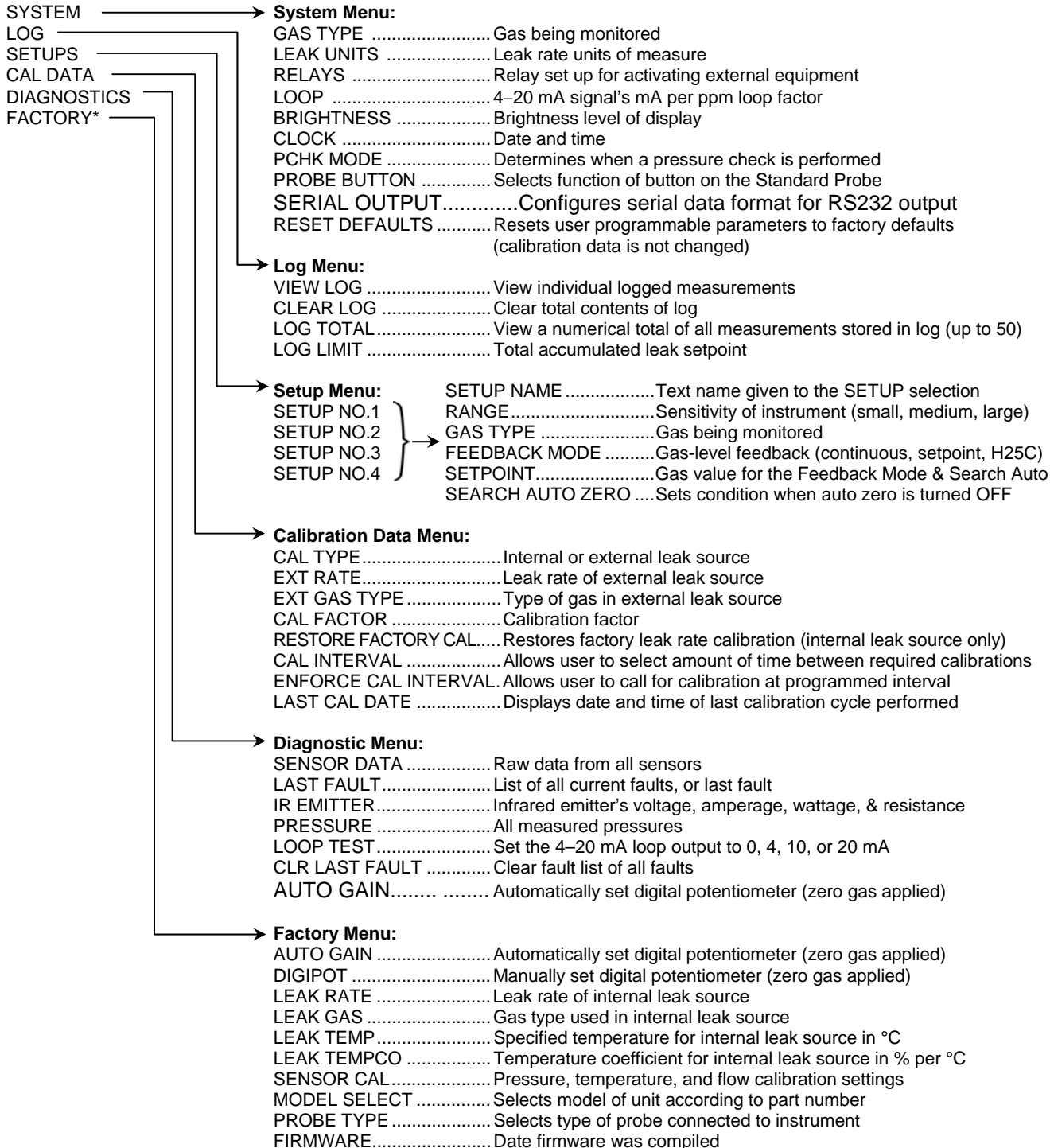

* The Factory Menu appears only when activated by service technicians who know the correct activation procedure.

2 Preparing for Operation

2.1 Connecting the Probe

Plug the probe connector into the front panel PROBE receptacle by aligning the red dots on both the connector and receptacle. Screw the desired flexible probe tube (8 or 15 inches) onto the probe assembly.

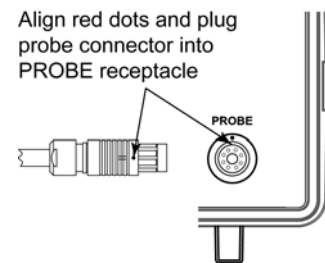

2.2 Connecting the AC Power Cord

Dependent on the instrument model the H25-IR may use an AC power cord or a battery pack. Reference your model number to obtain this information. Disregard any information that does not apply to your model.

The H25-IR is supplied with a 6 foot grounded AC power cord. Make sure that an AC power receptacle (socket) compatible with this plug is available nearby.

The instrument uses a universal AC power supply that accepts inputs of 100 to 240 VAC, 50/60 Hz. Power consumption is approximately 15 Watts.

Before connecting the AC power cord, first make sure the instrument's power switch is OFF. Next, connect the power cord to the instrument's rear panel AC power receptacle, and then plug the power cord into a nearby AC power receptacle.

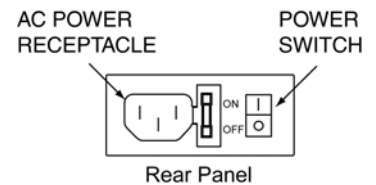

2.3 Battery Pack

The H25-IR can be ordered as a battery powered instrument. This will allow the user to work in areas where a receptacle is not easily accessible. This battery powered instrument can also operate on AC power when battery operation is not needed. The battery powered H25-IR comes with a padded carrying case with the following features:

- Inside pocket to hold the battery pack (included with battery pack kit)
- Side pocket to hold the charger (included with battery pack kit)
- Front outside pocket to hold the probe and power cord

2.4 Turning ON the Instrument



WARNING! Explosion Hazard. Do not operate this instrument in the presence of flammable liquids, vapors or aerosols. Operation of this instrument in such an environment constitutes a safety hazard.

Turn ON the instrument by setting its power switch, located on the rear panel, to ON.

BACHARACH
VERSION x.xx

When power is first applied, the instrument produces one short beep and then performs a self-diagnostic check while displaying the instrument's firmware version number (approx. 15 seconds).

Immediately afterwards, the instrument enters its warm-up mode and a countdown from 120 seconds is started. In addition, a graphical display of the countdown period is provided by a bar graph that moves down the screen during warm-up.



Remaining Warm Up Time in Seconds
Graphical Display of Warm Up Time

At the end of warm-up the Data Display screen appears. This screen shows the current gas measurement, leak units, gas type, setup name, range, and mode of operation. In addition, a graphical display of the relative gas level is provided by a bar graph that moves up the screen with increasing gas levels. Note that the sensitivity of the bar graph is dependent on the Range setting.

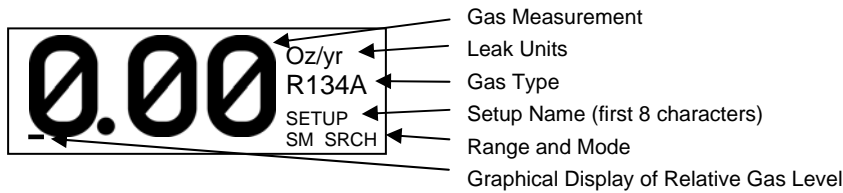

2.5 System Setup

When shipped from the factory, the H25-IR has been configured according to its part number as described in Appendix "A". To change any of the instrument's system parameters, first enter System Setup by pressing *both* the **ENT** and **ESC** buttons on either the instrument's front panel or Smart probe at the same time to display the Main menu. Next, use the **Up** and **Down** buttons to highlight "SYSTEM", and then press **ENT** to display the System Setup menu.

Main Menu:

```
SYSTEM
LOG
SETUPS
CAL DATA
DIAGNOSTICS
```

System Setup Menu:

```
GAS TYPE
LEAK UNITS
RELAYS
LOOP
BRIGHTNESS
CLOCK
PCHK MODE
PROBE BUTTON
RESET DEFAULTS
```

From the System Setup menu, use the **Up** and **Down** buttons to highlight the desired function. Press **ENT** to select that function and display its setup screen. Then perform the appropriate system setup procedure as described in Sections 2.5.1 thru 2.5.9.

2.5.1 Gas Type

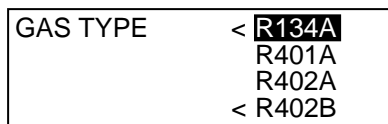

The GAS TYPE function displays a list of gases that the instrument is programmed to monitor. Refer to Section 6 for a complete list of these gases.

Use the **Up** and **Down** buttons to highlight the desired gas. Press **ENT** to save the selection.

2.5.2 Leak Units

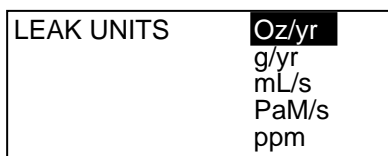

The LEAK UNITS function displays a list of leak rate units of measure that the instrument is capable of displaying. Leak rates can be displayed in units of ounces/year (Oz/yr), grams/year (g/yr), milliliters/second (mL/s), Pascal Meters³/second (PaM/s), or parts per million (ppm).

Use the **Up** and **Down** buttons to highlight the desired leak units. Press **ENT** to save the selection.

2.5.3 Relays

1 = NOT USED
2 = NOT USED
3 = NOT USED
4 = NOT USED

Four SPDT relays (rated 3 A, 240 VAC) can be individually programmed to energize under any one of 11 different operating conditions. The contacts of these relays can be connected to an external device that will activate when the designated operating condition is met. Refer to Section 2.7 *External Relay Connections*.

Use the **Up** and **Down** buttons to highlight the relay to be programmed. Press **ENT** to make the selection and display that relay's assignment screen.

Use the **Up** and **Down** buttons to highlight the desired operating condition for the selected relay. Press **ENT** to save the selection.

RELAY 1 ASSIGNED TO
NOT USED
CLOSE >= SETPOINT
CLOSE < SETPOINT
CLOSE ON FAULT
CLOSE DURING CAL
CLOSE IN MEASURE
CLOSE AT LOG LIMIT
CLOSE IN SETUP 1
CLOSE IN SETUP 2
CLOSE IN SETUP 3
CLOSE IN SETUP 4
CLOSE WHEN TESTING

NOTE: *SETPOINT* is the gas value as entered per Section "2.6.5 Setpoint."

LOG LIMIT is the total accumulated leak value as entered per Section "4.2.10.4 Setting the Log Limit."

For example: If Relay 1 is programmed to "CLOSE AT LOG LIMIT," its N.O. contacts can be connected to an external alarm device (e.g. strobe light or buzzer) that will activate when the total accumulated leak value in the data log has reached its programmed limit.

TIP: *When measuring the total leak-rate of a system, it's important to clear the log per Section "4.2.10.2 Clearing the Log" before starting a new series of leak-rate measurements.*

2.5.4 4–20 mA Loop

EDIT LOOP FACTOR
0.016ppm

Selecting the 4–20 mA LOOP function allows the current loop factor to be changed from its factory default of 0.016 ppm (corresponds to 0.016 mA per ppm), which provides an output range of 0 ppm (4 mA) to 1,000 ppm (20 mA). Refer to Equation 3.1.

Use the **Left** and **Right** buttons to move the blinking cursor across the screen to highlight the digit to be modified, and then use the **Up** and **Down** buttons to modify that digit. Press **ENT** to save the new loop factor.

$$\text{Loop Output in mA} = (\text{Loop Factor} \times \text{ppm}) + 4 \text{ mA} \quad \text{Eq. 3.1}$$

TIP: *The loop output can be checked per Section "5.1.5 Loop Test".*

2.5.5 Brightness

BRIGHTNESS
PRESS ARROW KEYS TO
ADJUST

The BRIGHTNESS function changes the brightness level of the instrument's front panel display.

Use the **Up**, **Down**, **Left**, or **Right** button to change the brightness to any one of four levels. Press **ENT** to save the selected brightness level.

2.5.6 Clock

SET DATE & TIME
07/16/04 13:13

The CLOCK function sets the instrument's date (MM/DD/YY) and time (24 hour format, where 1:00 PM is displayed as 13:00). The clock allows measured values to be logged with a date/time stamp (refer to Section 4.2.9 *Logging Measured Readings*).

Use the **Left** and **Right** buttons to move the blinking cursor across the screen to highlight the digits to be modified, and then use the **Up** and **Down** buttons to modify those digits. Press **ENT** to save the new date and time values.

2.5.7 PCHK Mode

PCHK MODE **AUTO**
AT CAL

The PCHK Mode setting determines when the instrument performs a ambient pressure check as follows:

AUTO – A pressure check is performed once every 60 minutes.

AT CAL – A pressure check is performed at the end of every calibration.

Note that a pressure check is always performed when the instrument is first turned ON just before the warm-up period begins, regardless of the PCHK Mode setting.

Use the **Up** and **Down** buttons to highlight the desired setting. Press **ENT** to save the selection.

2.5.8 Probe Button

PROBE BUTTON
DISABLED
MODE KEY
ENTER KEY

The PROBE BUTTON function selects what action is performed by the pushbutton on the Standard Probe with LED and Pushbutton.

DISABLED – No action performed.

MODE KEY – Toggles the instrument between its Search and Measure mode.

ENTER KEY – Performs the same function as the **ENT / ZERO** key on the instrument's front panel.

Use the **Up** and **Down** buttons to highlight the desired setting. Press **ENT** to save the selection.

2.5.9 Reset Defaults

CONFIRM RESET TO
DEFAULTS BY PRESSING
THE UP ARROW

The RESET DEFAULTS function returns the instrument to its factory default settings per Appendix "A".

This operation requires a three key press. Simultaneously press the ENTER+ESCAPE+VOL buttons to reset defaults.

2.6 Configuring the SETUPS Function

There are four user-defined Setups that allow the operator to quickly switch between frequently used combinations of Gas Type, Range, Feedback Mode, Setpoint, and the Auto Zero Off condition. Program the four Setup configurations as follows:

First enter the Setups menu by pressing *both* the **ENT** and **ESC** buttons on either the instrument's front panel or Smart probe at the same time to display the Main menu. Next, use the **Up** and **Down** buttons to highlight "SETUPS", and then press **ENT** to display the Setups menu.

Main Menu:

```
SYSTEM
LOG
SETUPS
CAL DATA
DIAGNOSTICS
```

Setups Menu:

```
SETUP NO. 1
SETUP NO. 2
SETUP NO. 3
SETUP NO. 4
```

Configuration Menu:

```
SETUP NAME
RANGE
GAS TYPE
FEEDBACK MODE
SETPOINT
SEARCH AUTO ZERO
```

NOTE: The names listed in the Setups menu are user defined, and may vary from what is shown above.

From the Setups menu, use the **Up** and **Down** buttons to highlight the desired Setup. Press **ENT** to select that Setup and display its Configuration menu.

From the Configuration menu, use the **Up** and **Down** buttons to highlight the desired function. Press **ENT** to select that function and display its setup screen. Perform the appropriate setup procedure as described in Sections 2.6.1 thru 2.6.6.

2.6.1 Setup Name

```
SETUP NAME #1
  SETUP NO. 1
```

The SETUP NAME function allows the operator to give each Setup a unique name that will appear on the Data Display screen. Use the **Left** and **Right** buttons to move the blinking cursor across the screen to highlight the character to be modified, and then use the **Up** and **Down** buttons to modify that character. When finished entering the desired characters, press **ENT** to save the new name.

2.6.2 Range

```
RANGE      LG
SETUP NO. 1 MED
           SM
```

The RANGE function sets the sensitivity of the gas-level graphical display (bar graph located at the bottom of the display), audible tone frequency, and the hand-held probe's LED blink rate in relation to the detected gas level. Use the **Up** and **Down** buttons to highlight the desired sensitivity. Press **ENT** to save the selection.

NOTE: The range setting has no affect on the accuracy of the gas reading as displayed on the instrument when making a leak-rate measurement.

2.6.3 Gas Type

GAS TYPE	< R134A
SETUP NO. 1	R401A
	R402A
	< R402B

The GAS TYPE function sets the type of gas being monitored. Use the **Up** and **Down** buttons to highlight the desired gas. Press **ENT** to save the selection.

NOTE: *The gases displayed depend on which optical bench is installed. Refer to Section “6.”*

2.6.4 Feedback Mode

FEEDBACK MODE	
SETUP NO. 1	CONTINUOUS
	SETPOINT
	H25C SETPOINT

The FEEDBACK MODE function provides the operator both visual and audible feedback in regard to the measured leak rate. This function determines how the gas-level graphical display (bar graph located at the bottom of the display) and audible tone operate as follows:

CONTINUOUS – The bar graph and audible tone continuously increase and decrease their values in step with the leak rate. For example, when the leak rate increases, the bar graph moves upscale and the audible tone increases in frequency. Their maximum values at various leak rates are determined by the Range setting.

SETPOINT – Both the bar graph and audible tone go to their maximum values when the leak rate equals or goes above the setpoint. Enter a setpoint value per Section 2.6.5 *Setpoint*.

H25C SETPOINT – This setting emulates the operation of the H25C Industrial Halogen Leak Detector. The bar graph and audible tone are suppressed when the leak rate is below the setpoint. They both go to their 50% values when the leak rate reaches the setpoint, and then they both continuously increase in value as the leak rate increases until reaching their maximum values at *2-times* the setpoint. Enter a setpoint value per Section 2.6.5 *Setpoint*.

Use the **Up** and **Down** buttons to highlight the desired function. Press **ENT** to save the selection.

2.6.5 Setpoint

SETPOINT	
SETUP NO. 1	00.0000 Oz/yr

The SETPOINT function establishes a leak rate at which the graphical display and audible tone are turned ON as determined by the Feedback Mode setting (refer to the previous section).

The setpoint value also sets the leak rate at which one or more of the instrument's relays is energized whenever the leak rate equals, exceeds, or falls below the setpoint value (refer to Section 2.5.3 *Relays*), plus it establishes a reference point where the instrument's auto-zero function can be turned OFF while in the Search mode (refer to Section 2.6.6 *Search Auto Zero*).

Use the **Left** and **Right** buttons to move the cursor across the screen to highlight the digit to be modified, and then use the **Up** and **Down** buttons to modify that digit. Press **ENT** to save the new setpoint.

2.6.6 Search Auto Zero

```

SEARCH AUTO ZERO
SETUP NO.1
  < ALWAYS ON
    ALWAYS OFF
    BELOW SETPOINT
    BELOW 90% OF SP
    BELOW 75% OF SP
    BELOW 50% OF SP

```

The SEARCH AUTO ZERO function allows the operator to select one of the following conditions when the auto-zero function is disabled while in the Search mode:

NOTE: *This function works in conjunction with the setpoint value as entered in Section “2.6.5 Setpoint.”*

ALWAYS ON – The background gas level is *always* zeroed. If the probe is held over a gas leak, the instrument will automatically zero-out the reading.

ALWAYS OFF – The background gas level is *never* zeroed. If the probe is held over a gas leak, the instrument will not zero-out the reading, similar in operation to the Measure mode.

BELOW SETPOINT – The auto-zero function is ON when the leak-rate is *below* the setpoint value. If the leak rate goes *above* the setpoint value, then the auto-zero function turns OFF, allowing the probe to stay on the leak without the reading being zeroed-out.

For example: If the Setpoint is 2 Oz/yr, then the auto-zero function is ON for leaks rates that are <2 Oz/yr. If the leak rate is ≥ 2 Oz/yr, then the auto-zero function turns OFF.

BELOW 90% OF SP – The auto-zero function is ON when the leak-rate is *below* 90% of the setpoint value. If the leak rate goes *above* 90% of the setpoint value, then the auto-zero function turns OFF, allowing the probe to stay on the leak without the reading being zeroed-out.

For example: If the Setpoint is 2 Oz/yr, then the auto-zero function is ON for leaks rates that are <1.8 Oz/yr. If the leak rate is ≥ 1.8 Oz/yr, then the auto-zero function turns OFF.

BELOW 75% OF SP – The auto-zero function is ON when the leak-rate is *below* 75% of the setpoint value. If the leak rate goes *above* 75% of the setpoint value, then the auto-zero function turns OFF, allowing the probe to stay on the leak without the reading being zeroed-out.

For example: If the Setpoint is 2 Oz/yr, then the auto-zero function is ON for leaks rates that are <1.5 Oz/yr. If the leak rate is ≥ 1.5 Oz/yr, then the auto-zero function turns OFF.

BELOW 50% OF SP – The auto-zero function is ON when the leak-rate is *below* 50% of the setpoint value. If the leak rate goes *above* 50% of the setpoint value, then the auto-zero function turns OFF, allowing the probe to stay on the leak without the reading being zeroed-out.

For example: If the Setpoint is 2 Oz/yr, then the auto-zero function is ON for leaks rates that are <1 Oz/yr. If the leak rate is ≥ 1 Oz/yr, then the auto-zero function turns OFF.

2.7 External Relay Connections

The H25-IR includes four SPDT relays whose relay contacts are rated 3 A at 240 VAC. External alarm devices (e.g., horns, bells, strobe lights, etc.) can be connected to these relays and activated when their associated relay is energized. Refer to Section 2.5.3 *Relays*.

Locate the external relay connector on rear of unit (refer to Section 1.7.2 *Rear View*).

Secure the leads from the external device and its power source to the external relay connector as shown in the diagram below. This diagram shows a typical alarm device being connected to Relay 1. Repeat this procedure, as necessary, for the remaining relays.

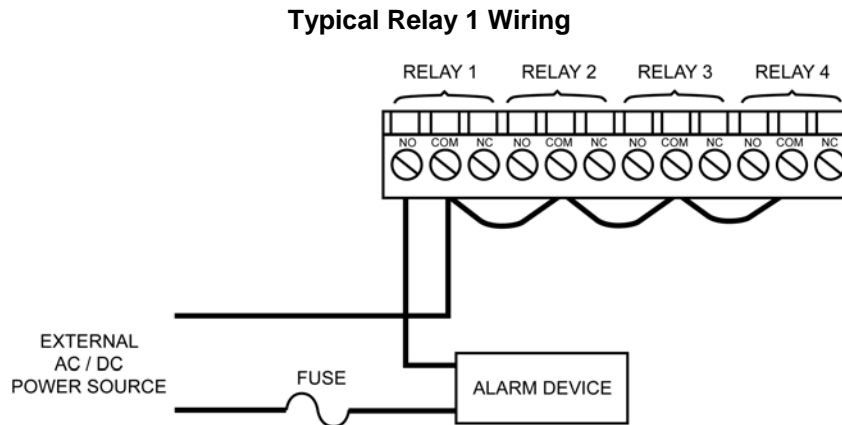

- Each relay may be connected as normally open (NO), or normally closed (NC).
- The relay contacts are rated 3 A at 250 VAC.
- Power for the external alarm devices is supplied from an external power source.
- Jumper the 'Neutral' line of an external power source to the 'Common' terminals on the relay connector.
- Connect one end of the alarm device to the 'NO' terminal of the desired relay.
- The other end of the alarm device is connected to the other leg of the external power source. For protection, install an in-line fuse of the appropriate size and design for the external alarm device being used.

2.8 4–20 mA Current Loop Connection

An external 4–20 mA monitoring device (e.g., chart recorder) can be connected to the H25-IR using a shielded-twisted-pair cable.

IMPORTANT! *The monitoring device must be isolated from ground (floating).*

Locate the 4–20 mA connector on the rear of the unit (refer to Section 1.7.2 *Rear View*), and then remove the resistor or shorting wire from its terminals.

NOTE: *A 100 ohm, ¼ W resistor must be connected to the 4–20 mA connector if no external monitoring device is used. Failure to install this resistor will cause a “Loop Open Error” to occur (refer to Section “4.3 Fault”).*

Secure the wire leads from the external monitoring device to the connector as shown in the diagram below, making sure that the polarity at this connector matches the wiring at the monitoring device.

4–20 mA Current Loop Connector

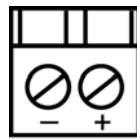

CAUTION: *Never apply power to the 4–20 mA Current Loop Connector from an external power supply. In addition, connect only a load resistor or a **floating** measurement device.*

The default current-to-ppm factor is set to 0.016 mA = 1 ppm, providing a measurement range of 0 ppm (4 mA) to 1,000 ppm (20 mA). Note that the current-to-ppm factor can be changed using the instrument’s LOOP function (refer to Section 2.5.4 4–20 mA Loop).

TIP: *The loop output can be checked per Section “5.1.5 Loop Test”.*

Notes:

3 Calibration

It is recommended that a calibration be performed after the initial warm up and then once every 2-4hours hours there after. During the calibration cycle internal pressures and flow rates are stored which are used to determine leak rate and detect proper flow. A flow fault indicates a change in pressure since the time of the last calibration cycle. This can be due to particulate build up on the probe tip or internal filters as well as swings in atmospheric pressure due to weather changes (if a long time has elapsed since the last calibration cycle). Most flow faults can be cleared by simply performing a new calibration.

When the instrument is supplied with an internal leak source, the operator can choose between two types of calibration: **Internal** or **External**. Internal calibration uses the instrument's built-in leak source, while External calibration uses a customer supplied calibrated leak source.

If the instrument is supplied without a leak source, then the option of selecting the calibration type is removed from the menu system. The only option for this model of instrument is to calibrate using an external leak source.

3.1 Selecting Internal or External Calibration

Use the Main Menu > CAL DATA > CAL TYPE function to select either Internal or External calibration. If External calibration is selected, then also use the EXT RATE and EXT GAS TYPE functions to enter the characteristics of the external leak source.

Display the Calibration Data menu by first pressing *both* the **ENT** and **ESC** buttons on either the instrument's front panel or Smart probe at the same time to display the Main menu. Next, use the **Up** and **Down** buttons to highlight "CAL DATA", and then press **ENT** to display the Calibration Data menu.

Main Menu:

```
SYSTEM
LOG
SETUPS
CAL DATA
DIAGNOSTICS
```

—————> Calibration Data Menu:

```
CAL TYPE
EXT RATE
EXT GAS TYPE
CAL FACTOR
RESTORE FACTORY CAL
CAL INTERVAL
ENFORCE CAL INTERVAL
LAST CAL DATE
```

3.1.1 Internal Calibration Selection

From the Calibration Data menu, use the **Up** and **Down** buttons to highlight "CAL TYPE", and then press **ENT** to display its setup screen. Use the **Up** and **Down** buttons to highlight "INTERNAL", and press **ENT** to make the selection and return to the Calibration Data menu. Press **ESC** as required to return to the Data Display screen.

```
CAL TYPE  INTERNAL
          EXTERNAL
```

3.1.2 External Calibration Selection and Setup

When using an external leak source, the instrument must be setup for external calibration along with entering the leak rate and gas type of the external leak source.

Select external calibration and enter the parameters of the external leak source as follows:

Select External Calibration: From the Calibration Data menu, use the **Up** and **Down** buttons to highlight “CAL TYPE”, and then press **ENT** to display its setup screen. Use the **Up** and **Down** buttons to highlight “EXTERNAL”, and press **ENT** to make the selection and return to the Calibration Data menu.

CAL TYPE	INTERNAL
	EXTERNAL

Enter External Leak Rate: From the Calibration Data menu, highlight “EXT RATE” and press **ENT** to display its setup screen. Use the **Left** and **Right** buttons to move the blinking cursor across the screen to highlight the digit to be modified, and then use the **Up** and **Down** buttons to modify that digit. Press **ENT** to save the new external leak rate value and return to the Calibration Data menu.

IMPORTANT! *Be sure to enter the leak rate using the same units of measure as displayed on the EXT RATE screen. In this example, the units of measure is g/yr. If your leak source is marked in Oz/yr, then multiply that value by a factor of **28.35**. For example: If the leak source is marked 0.9 Oz/yr, then enter a leak rate of $(0.9 \times 28.35=)$ 25.5 g/yr.*

NOTE: *The minimum calibration leak rate is 2 g/yr.*

EXT RATE 25.5 g/yr

Enter External Gas Type: From the Calibration Data menu, highlight “EXT GAS TYPE” and press **ENT** to display its setup screen. Use the **Up** and **Down** buttons to highlight the type of gas contained in the external leak source. Press **ENT** to save the new external gas type and return to the Calibration Data menu.

NOTE: *The gases displayed depend on which optical bench is installed. Refer to Section “6 Troubleshooting.”*

EXT GAS TYPE	< R134A
	R401A
	R402A
	< R402B

Press **ESC** as required to return to the Data Display screen.

3.2 Internal Calibration

Internal calibration uses the instrument’s built-in leak source. Properties of the leak source (i.e. gas type, leak rate, temperature coefficient, and specification temperature) are entered at the factory and do not need to be changed by the operator.

The properties of the leak source along with the current internal temperature of the instrument are used to compute the actual leak rate when a calibration is requested. This number is displayed as the “target” value during calibration. A spring switch located in front of the CAL Port ensures that the probe is kept in place for the duration of the calibration process. Calibration will fail if the probe is withdrawn too early in the process, or if the computed parameters deviate from the stored factory calibration by more than 20%.

1. Turn ON instrument and allow it to complete its 120 second warm-up.

- Press the front panel **CAL** button to display the Calibration screen. Note that the display must be reading a leak rate of "0.00" when the **CAL** button is pressed; otherwise, the message "LEAK RATE MUST BE ZERO TO CALIBRATE" will appear. If necessary, press the **ZERO** button to zero the display before pressing **CAL**.

0.89	TARGET	Oz/yr
INSERT	O/YR	R134A
PROBE	R134A	
	MEASURED	SETUP
	O/YR	INT CAL

- Ensure that the instrument is set up for internal calibration as indicated by "INT CAL" being displayed at the bottom-right of the display. If "EXT CAL" (external calibration) is displayed, press the ESC key to perform the procedure in Section 3.1 *Selecting Internal or External Calibration* and set the Cal Type to **Internal**.
- Insert the probe tip into the CAL Port within 10 seconds after pressing the **CAL** button. Be sure that the probe tip makes contact with the spring switch. At this time the calibration process should automatically start.

The top number of the Calibration screen shows the "target" value (leak source rate), while the bottom number shows the current measured value. Keep the probe tip firmly against the back of the port for the duration of the calibration process, during which time the instrument is calibrated at both a high and low flow rate.

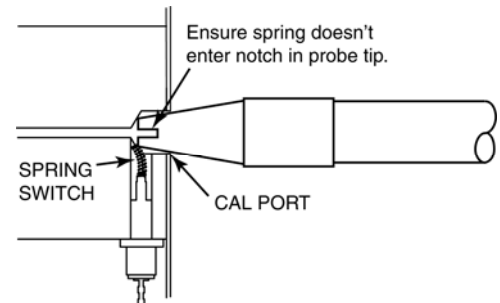

If the probe tip loses contact with the spring switch before the calibration process completes, the message "CAL ABORTED" is displayed. At this time press any key to retain the previous calibration curve and return to the Data Display screen.

- After a successful calibration the new calibration data is saved and the message "CAL OK" followed by "WITHDRAW PROBE FROM LEAK SOURCE" will appear.
- Withdrawing the probe causes the display to switch back to the Data Display screen. Note, however, if the PCHK Mode is set to AUTO (refer to Section 2.5.7 *PCHK Mode*), then a pressure check is performed prior to the display of the Data Display screen.

NOTE: After being calibrated the instrument is automatically placed into its Search mode.

0.89	TARGET	Oz/yr
0.00	O/YR	R134A
	R134A	
	MEASURED	SETUP
	O/YR	INT CAL
CAL OK		Oz/yr
		R134A
		SETUP
		INT CAL
WITHDRAW PROBE FROM LEAK SOURCE		Oz/yr
		R134A
		SETUP
		INT CAL
		PCHK
0.00		Oz/yr
		R134A
		SETUP
		SM SRCH

3.3 External Calibration

External calibration uses a customer supplied leak source that matches the gas to be monitored. Properties of the leak source must be entered by the operator using the EXT RATE and EXT GAS TYPE functions as described in Section 3.1.2 *External Calibration Selection and Setup*. The EXT RATE entry is the number displayed as the "target" value during calibration.

IMPORTANT! The operator is responsible for ensuring that the external leak-rate value has been corrected for daily changes in ambient temperature and pressure at the time of calibration. It is also **the operator's responsibility** to ensure that a good calibration has been performed.

- Turn ON instrument and allow it to complete its 120 second warm-up.
- Press the front panel **CAL** button to display the Calibration screen. Note that the display must be reading a leak rate of "0.00" when the **CAL** button is pressed; otherwise, the message "LEAK RATE

"MUST BE ZERO TO CALIBRATE" will appear. If necessary, press the **ZERO** button to zero the gas display before pressing **CAL**.

0.89	TARGET O/YR R134A	Oz/yr R134A
0.00	MEASURED O/YR	SETUP EXT CAL

- Ensure that the instrument is set up for "EXT CAL" (external calibration) as indicated at the bottom-right of the display. If "INT CAL" (internal calibration) is displayed, press the ESC key to perform the procedure in Section 3.1 *Selecting Internal or External Calibration* and set the Cal Type to **External**.
- Insert probe tip into the Calibration Port of the external leak source.
- The top number of the Calibration screen shows the "target" value (leak source rate), while the bottom number shows the current "measured" value. Keep the probe tip inserted in the Calibration Port for the duration of the calibration process, during which time the instrument performs a calibration at both a high and low flow rate.

0.89	TARGET OZ/YR R134A	Oz/yr R134A
0.89	MEASURED OZ/YR	SETUP EXT CAL

- After the calibration cycle is complete, the new calibration data is saved and the display automatically switches back to the Data Display screen. Note, however, if the PCHK Mode is set to AUTO (refer to Section 2.5.7 *PCHK Mode*), then a pressure check is performed prior to the display of the Data Display screen.

0.00	Oz/yr R134A
	SETUP SM SRCH

NOTE: After calibration the instrument is automatically placed into its Search mode.

3.4 CAL Factor

The factory default CAL Factor of 1.000 will provide the level of accuracy as stated in Section 6 *Troubleshooting* for all gases.

The CAL Factor can be changed for the following two reasons:

- Allow the instrument's internal leak source to be used to calibrate the instrument, regardless of the gas being measured
- Improve the accuracy of ppm measurements

Leak-rate accuracy can be maintained by periodically calibrating the instrument on the gas being measured. If the instrument's internal calibration gas is the same as the gas being measured, then it is a simple matter of calibrating the instrument using the internal leak source. When measuring a gas that is not the same as the instrument's internal calibration gas, then there are two options for maintaining accuracy. The instrument can either be calibrated using an external leak source, or the CAL Factor can be adjusted to make the internal leak source simulate the gas being measured as described in Section 3.4.1.

The CAL Factor can also be used to improve the accuracy of ppm measurements as described in Section 3.4.2.

3.4.1 Simulating Other Internal Leak Source Gas Types Using the CAL Factor

When measuring the leak rate of a gas that is not the same as the instrument's internal calibration gas, the CAL Factor can be adjusted make the instrument's internal calibration gas simulate the gas being measured. This allows the operator to calibrate the instrument using the internal leak source, regardless of the gas contained in the leak source. Note that this procedure is not necessary for single-gas instruments.

Material Required:

- Calibrated External Leak Source set up for 5 to 10 times the leak rate that the instrument is expected to detect

IMPORTANT! *Remember that the accuracy will not be better than that of the external leak source used for calibration.*

Procedure:

1. Turn ON the instrument and allow it to warm up for 30 minutes before proceeding.
2. Program the instrument for the Gas Type contained in the external leak source (refer to Section 2.5.1 Gas Type).
3. Verify that the current CAL Factor is set to 1.000 by selecting the Main Menu > CAL DATA > CAL FACTOR function. If necessary, reset the CAL Factor to 1.000. Refer to Section 3.4.3 Adjusting the CAL Factor.
4. Perform an internal calibration in the normal way using the internal leak source (refer to Section 3.2 Internal Calibration). Note that it doesn't matter that the gas in the internal leak source doesn't match the Gas Type entered in Step 2.
5. Press the MODE key to place the instrument into its Measure mode.
6. Measure the leak rate of the external leak source and record the displayed reading.
7. Compute the new CAL Factor by dividing the actual leak rate of the external leak source by the reading recorded in Step 6. For example, if the leak rate of the external leak source is 0.4 oz/yr and the measured rate was 0.43 oz/yr, then the new CAL Factor is $0.4 \div 0.43 = \mathbf{0.930}$.

This new CAL Factor establishes the relationship between the internal calibration gas and the gas type selected to be measured.

8. Enter the new CAL Factor as described in Section 3.4.3 Adjusting the CAL Factor. Note that the displayed Gas Type should match the gas selected in Step 2.
9. From this point on the operator can perform an internal calibration and get accurate measurements for other gas types using whatever gas is contained in the internal leak source.

3.4.2 Improving PPM Measurement Accuracy using the CAL Factor

The CAL Factor can be adjusted to improve the accuracy of the ppm measurement by calibrating the instrument on the gas being measured. The accuracy of the ppm measurement after performing this procedure will equal the accuracy of the gas sample, $\pm 1\%$. Note that the accuracy of the instrument's ppm measurement depends on the accuracy of the gas sample.

The new CAL Factor is determined by sampling a known dilution of gas whose accuracy is better than the ppm measurement accuracy as stated in Section 6 Troubleshooting. The concentration of the sample must also be corrected for ambient temperature and pressure at the time of calibration. A minimum sample size of 5 liters is required.

Calibration is best performed at or near full scale, it can however, be done at any concentration and ideally in the range where maximum accuracy is desired down to, but not below, 100 ppm.

The instrument should be operating for at least 30 minutes prior to performing a calibration.

Verify that the current CAL Factor is set to 1.000 by selecting the Main Menu > CAL DATA > CAL FACTOR function. If necessary, reset the CAL Factor to 1.000. Refer to Section 3.4.3 *Adjusting the CAL Factor*.

With the instrument operating in its ppm measurement mode (refer to Section 4.2.8 *Measuring the PPM Level*), insert the probe tip into the gas-sample bag and allow the instrument to sample until the ppm reading on the display is stable. At this time record the ppm reading. The new CAL Factor is computed by dividing the known gas concentration value by the measured value. Typically this number will be between 0.95 and 1.05. Enter the new CAL Factor as described in Section 3.4.3 *Adjusting the CAL Factor*.

IMPORTANT! *If the instrument is switched back to measuring the leak-rate, then the instrument must be recalibrated on the gas being measured.*

3.4.3 Adjusting the CAL Factor

Display the Calibration Data menu by first pressing *both* the **ENT** and **ESC** buttons on either the instrument's front panel or Smart probe at the same time to display the Main menu. Next, use the **Up** and **Down** buttons to highlight "CAL DATA", and then press **ENT** to display the Calibration Data menu.

Main Menu:

```
SYSTEM
LOG
SETUPS
CAL DATA
DIAGNOSTICS
```

Calibration Data Menu:

```
CAL TYPE
EXT RATE
EXT GAS TYPE
CAL FACTOR
RESTORE FACTORY CAL
CAL INTERVAL
ENFORCE CAL INTERVAL
LAST CAL DATE
```

From the Calibration Data menu, highlight "CAL FACTOR" and press **ENT** to display its setup screen. Use the **Left** and **Right** buttons to move the blinking cursor across the screen to highlight the digit to be modified, and then use the **Up** and **Down** buttons to modify that digit. Press **ENT** to save the new CAL factor value and return to the Calibration Data menu.

```
CAL FACTOR 1.000
FOR R134A
K1=310.89 K2=703.7 K3=1460.3
K4=0.0 K5=0.0
```

3.5 Restoring Factory Calibration

NOTE: *Factory calibration cannot be restored if the instrument was calibrated using an **external** leak source.*

Restore an instrument to its factory calibration value as follows:

Display the Calibration Data menu by first pressing *both* the **ENT** and **ESC** buttons on either the instrument's front panel or Smart probe at the same time to display the Main menu. Next, use the **Up** and **Down** buttons to highlight "CAL DATA", and then press **ENT** to display the Calibration Data menu.

Main Menu:

```
SYSTEM
LOG
SETUPS
CAL DATA
DIAGNOSTICS
```

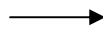

Calibration Data Menu:

```
CAL TYPE
EXT RATE
EXT GAS TYPE
CAL FACTOR
RESTORE FACTORY CAL
CAL INTERVAL
ENFORCE CAL INTERVAL
LAST CAL DATE
```

From the Calibration Data menu, use the **Up** and **Down** buttons to highlight "RESTORE FACTORY CAL", and then press **ENT** to display the RESTORE FACTORY CAL screen.

```
RESTORE FACTORY CAL
HIT ENTER TO CONFIRM
```

Press the **ENT** button to confirm restoring the instrument to its factory calibration values.

3.6 Storing a New Factory Calibration

For all models fitted with an internal leak source, "factory" calibration data is stored in memory and used to validate all subsequent internal calibrations performed by the user. An internal calibration failure will occur when the calibration data collected during an internal calibration cycle, performed by the user, deviates from the "factory" calibration data. This can occur when the internal particulate filter needs to be replaced or if a probe is changed. When the internal filter or probe is replaced, or the optical sensor, pump or pneumatics is serviced, a new "factory" calibration must be stored. This is accomplished by first performing an internal calibration, which may fail due to the changes to the instrument, then pressing the ENT and CAL keys together.

```
PRESS ENTER TO
STORE LAST CAL
AS REFERENCE
```

g/yr	FAULT
SETUP NO.1	
SM SRCH	

```
LAST CAL HAS
BEEN STORED
AS REFERENCE
```

g/yr	FAULT
SETUP NO.1	
SM SRCH	

Press ENT to confirm. This will take the data collected from the calibration just completed and store it as the "factory" or reference calibration for validation of all future internal calibrations.

Notes:

4 Operation

4.1 Instrument Location

The H25-IR Refrigerant Gas Leak Detector should be placed on a flat, horizontal surface such as a bench or table top when in use.

When searching for leaks, the instrument does not need to be in a gas-free area. This is because of the instrument's ability to automatically zero-out background gases and still be able to locate gas leaks.

When making leak-rate measurements, the instrument needs a location where the air is clean and free of the gas being monitored – this is necessary for zeroing purposes. If the area is contaminated, then a fresh-air source (e.g., fresh air piped in from the outside) must be made available so the operator can manually zero the instrument before making a measurement.

4.2 Using the H25-IR

4.2.1 Power

Plug the instrument into the nearest AC outlet (100 to 240 VAC, 50/60 Hz) or use the battery pack (depending on your model number), and then set the rear panel power switch to its ON position. After power up, the instrument requires 120 seconds to warm-up. A detailed description of the front panel display screens that are shown during turn-on and warm-up is contained in Section 2.3 *Battery Pack*.

4.2.2 Initial Setup

At this time the H25-IR should already be set up as described in Section 2 *Preparing for Operation*.

After warming up, the instrument's Data Display screen will show the current Gas Measurement, Leak Units, Gas Type, Setup Name, Range, and Mode of Operation. In addition, a graphical display of the relative gas level is provided by a bar graph at the bottom of the screen whose length increases up the screen as the gas level increases. An audible tone may also be heard whose pitch increases in frequency as the gas level increases. Note that the sensitivity of the bar graph and audible tone for any given gas level is dependent on the Range setting.

When using the Smart probe, its LCD will show the current Gas Measurement, Range, Mode of Operation, and Setup Number in parentheses. If the probe contains a red LED, the blink rate of the LED will increase as the gas level increases. Note that the sensitivity of the LED's blink rate for any given gas level is dependent on the Range setting.

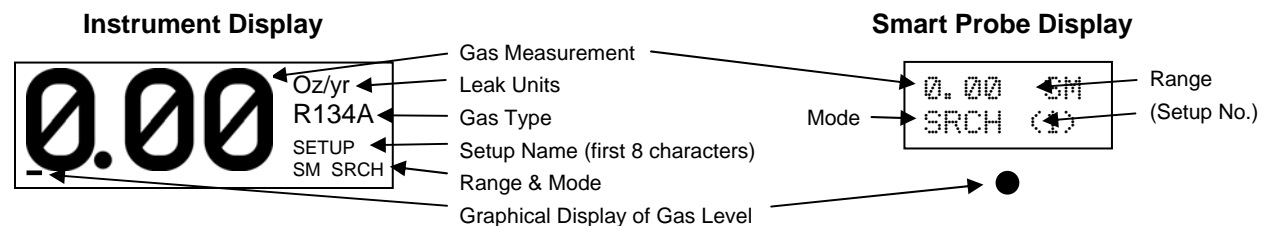

The Leak Units can be changed per Section 2.5.2 *Leak Unit*; the Gas Type changed per Section 2.5.1 *Gas Type*; the Setup changed by pressing the **SETUP** button; the Range changed by pressing the **RANGE** button; and the Mode changed by pressing the **MODE** button. Note that if the Gas Type is changed during operation, the Setup Name and Number changes to a dash (-), indicating that the previously selected Setup is no longer valid.

4.2.3 Range Selection

The H25-IR has three sensitivity ranges: SM (small), MED (medium), and LG (large). The range used when searching for a leak depends on the size of the leak and the type of gas being monitored.

Press the **RANGE** button until the desired range is displayed on either the instrument's Data Display screen, or on the LCD of the Smart probe.

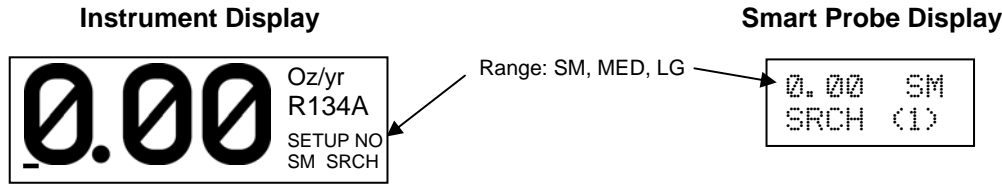

NOTE: The range setting has no effect on the accuracy of the gas reading as displayed on the instrument when making a leak-rate measurement. It does, however, change the sensitivity of the bar graph at the bottom of the Data Display screen, the audible tone frequency as heard from the speaker, and the blink rate of the red LED on the hand-held probe.

The “SM” range is the highest sensitivity level, and is most likely used for fluorine based gases like R134a and most fluorine based refrigerant blends.

The “MED” range is used for chlorine and chlorine based gases like R12, R22, R123, etc. This position is also useful for locating large R134a or other fluorine based refrigerant leaks of 1–2 Oz/yr.

The “LG” range is used to locate very large leaks.

TIP: Blowing out the test area with shop air may enable the operator to locate a large leak more quickly.

4.2.4 Setup Selection

There are four user-defined Setups that allow the operator to quickly switch between frequently used combinations of Gas Type, Range, Feedback Mode, Setpoint, and the Auto Zero Off condition (refer to Section 2.6 Configuring the *SETUPS* Function).

When first turned ON, the instrument returns to the last Setup selected. To select a different Setup, first press the **SETUP** button to display the Setup Selection menu. Next, use the **Up** and **Down** buttons to highlight the desired Setup, and then press **ENT** to make the selection and be returned to the Data Display screen. The name of the newly selected Setup will appear on the Data Display screen.



NOTE: The names listed in the Setup Selection menu are user defined, and may vary from what is shown above. The number of each setup, however, is what appears on the display of the Smart probe.

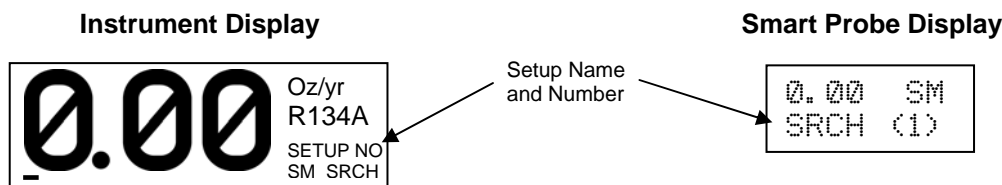

4.2.5 Volume Adjustment

A speaker at the rear of the instrument produces an audible tone whose frequency increases as the detected level of gas increases. An earphone when plugged into the instrument's earphone jack automatically disconnects the speaker, allowing the operator to listen to the unit's audible tone in high-noise environments.

TIP: If additional volume is required, connect an amplified speaker to the earphone jack.

Adjust the speaker and earphone volume as follows:

1. Press the **VOL** (volume) button to display the ADJUST SPEAKER VOLUME screen.



2. Press the **Up** button to increase volume, and press the **Down** button to decrease volume. Pressing the **Left** button sets the volume to minimum, while pressing the **Right** button sets it to maximum. A visual indication of the volume level is provided by a bar graph at the bottom of the Data Display screen.
3. Press **ENT** to save the new volume level.

4.2.6 Searching for a Leak

Use the following procedure to locate a leak.

1. Press the **MODE** button to display “SRCH” at the bottom of the Data Display screen or on the Smart probe.

The Search Mode is used to locate leaks because of its ability to auto-zero or block out background contamination. This greatly reduces and/or eliminates false positives while retaining the sensitivity to quickly locate small to large leaks.

TIP: The auto-zero function can be turned OFF, or configured to automatically turn OFF at a user-defined leak rate. Refer to Section “2.6.6 Search Auto Zero”.

2. Begin leak testing by moving the probe tip slowly toward the area being tested. Pinpointing leaks requires **continuous probe movement**. (2 inches [50 mm] per second is recommended as specified in SAE J1627 and J1628.) When the gas being monitored is detected the instrument responds in a positive manner as follows:
 - The gas reading increases
 - The bar graph at the bottom of the Data Display screen moves upscale
 - The audible tone from the speaker increases in frequency
 - If the hand-held probe contains an LED, its blink rate will increase
3. If the probe tip is held over the leak source the instrument will zero-out the leak, causing all gas indicators to return to their idle state. Briefly moving the probe away from the leak allows the instrument to quickly regain its sensitivity. Returning to the leak source will again cause the instrument to respond in a positive manner.
4. By repeating Step 3, the instrument will reliably and repeatedly pinpoint the leak with each pass over the leak source.

4.2.7 Measuring the Leak Rate

After finding a leak, a measurement can be made to determine its leak rate as follows:

1. Press the **MODE** button to display “MERS” at the bottom of the Data Display screen or “MEASR” on the Smart probe.
2. Allow the instrument to sample fresh air. The gas reading **must** be “0.00” before proceeding. If necessary, press the **ZERO** button to zero the reading while sampling fresh air.

- While observing the gas reading, hold the probe tip over the leak source until the reading stabilizes. In the examples below, a leak rate of 2.80 Oz/yr of R134a is being measured.

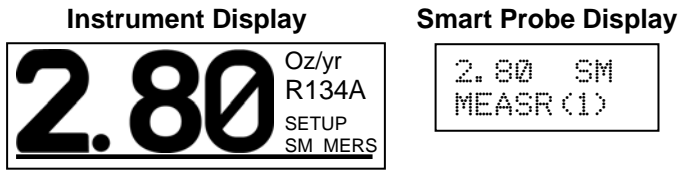

4.2.8 Measuring the PPM Level

The H25-IR can be used to measure a gas’s ppm level within a confined space, and display that level within the range of 0 to 1,000 ppm. Set up the instrument to measure ppm levels as follows:

NOTE: *Although the H25-IR can display ppm levels above its rated range of 0 to 999 ppm, the accuracy of the reading above 999 ppm is unspecified. Refer to Section “6Troubleshooting.”*

- Set up the instrument’s Leak Units to ppm as described in Section 2.5.2 *Leak Unit*.
- Press the **MODE** button to display “MERS” at the bottom of the Data Display screen or “MEASR” on the Smart probe.
- Allow the instrument to sample fresh air. The gas reading **must** be “00.0” before proceeding. Press the **ZERO** button to zero the gas reading while sampling fresh air.
- Place probe in area to be measured. In the example below, 38.0 ppm of R134a is being measured. Note that the display is auto ranging, causing the decimal point to turn off above 99.9 ppm.

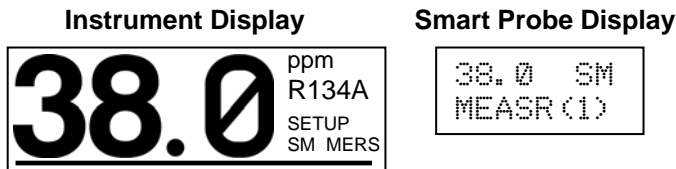

4.2.9 Logging Measured Readings

The H25-IR can log up to 50 measurements, which can then be viewed and analyzed at a later time. Each logged measurement is given a date & time stamp for identification. The measurements are stored in non-volatile memory, and will not be erased when the instrument is turned OFF.

With the instrument in its **Measure** mode, press the **LOG** button to log the measurement that is currently being displayed on the Data Display screen. Note that logged data is stored on a first-in, first-out basis. Once 50 measurements have been stored, the newest stored measurement overwrites the oldest.

NOTE: *Only non-zero measurements will be logged.*

In the following example, a reading of 0.48 Oz/yr is about to be logged in memory location 11. Pressing the **ENT** button will confirm this action and then display a Measurement Logged screen, which confirms that the data has been saved while also showing the current total of all leaks logged.



IMPORTANT! *The instrument does not perform a units-of-measure conversion. It is therefore very important that the operator not change the leak units value after beginning to log measurements.*

TIP: When measuring the total leak-rate of a system, it's important to clear the log per Section "4.2.10.2 Clearing the Log" before starting a new series of leak-rate measurements.

4.2.10 Logged Measurements

Each of the 50 logged measurements can be individually viewed, or the total accumulated value of all 50 measurements can be displayed. In addition, a log limit can be set that establishes a set point at which a relay is energized when the total of all logged measurements (up to 50) equals the log limit.

Enter the Log menu by first pressing *both* the **ENT** and **ESC** buttons on either the instrument's front panel or Smart probe at the same time to display the Main menu. Next, use the **Up** and **Down** buttons to highlight "LOG", and then press **ENT** to display the Log menu.

Main Menu:

```

SYSTEM
LOG  → Log Menu:
SETUPS
CAL DATA
DIAGNOSTICS
VIEW LOG
CLEAR LOG
LOG TOTAL
LOG LIMIT

```

4.2.10.1 Viewing Logged Measurements

Display the Log menu as described in Section 4.2.10. Next, use the **Up** and **Down** buttons to highlight "VIEW LOG" and then press the **ENT** button to display the first logged data point.

```

LOG POINT # 1
08/09/04 07:35
LEAK RATE=2.80 Oz/yr
L/R ARROW TO CLEAR

```

Use the **Up** and **Down** buttons to scroll through the other log points (1 thru 50).

Use the **Left** or **Right** button to clear only the current log point. To clear all log points, refer to Section 4.2.10.2 *Clearing the Log*.

4.2.10.2 Clearing the Log

Display the Log menu as described Section 4.2.10. Next, use the **Up** and **Down** buttons to highlight "CLEAR LOG" and then press the **ENT** button to display the Clear Log screen.

```

CLEAR LOG
HIT ENTER TO CONFIRM

```

Press the **ENT** button to clear the log of all stored measurements.

```

CLEAR LOG
CLEARING LOG DATA.

```

4.2.10.3 Viewing the Total of All Logged Measurements

The ability to display the total of all logged measurements (up to 50) is useful in situations where it is necessary to test an installation or piece of equipment that has a maximum permissible total leak rate. For example, a halogen fire suppression system can have leaks, but the combined leak rate or the sum of all the leaks cannot exceed a certain level, which is typically specified as a fraction of the total charge per year.

To display the total of all logged measurements, first display the Log menu as described Section 4.2.10. Next, use the **Up** and **Down** buttons to highlight "LOG TOTAL" and then press the **ENT** button to display the Log

Total screen. Note that the display is auto ranging, causing the decimal point to turn off above the value 99.9. In the example below, the total of all logged measurements is 78.5 Oz/yr.

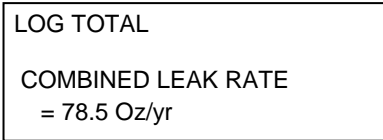

4.2.10.4 Setting the Log Limit

The ability to set a log limit is useful when using the H-25IR to log the leak rate of a system that has a maximum permissible total leak rate. A relay can be programmed to energize when the total of all logged measurements (up to 50) equals the log limit (refer to Section 2.5.3 Relays).

To set the log limit, first display the Log menu as described in Section 4.2.10. Next, use the **Up** and **Down** buttons to highlight "LOG LIMIT" and then press the **ENT** button to display the Log Limit screen. Use the **Left** and **Right** buttons to move the blinking cursor across the screen to highlight the digit to be modified, and then use the **Up** and **Down** buttons to modify that digit. Press **ENT** to save the log limit value and return to the Log menu.

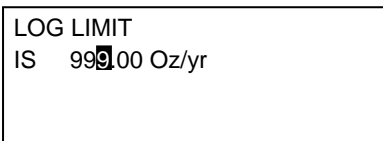

4.3 Fault Conditions

When the instrument's diagnostics detects that a fault has occurred, the word "FAULT" appears in place of the Gas Type, and a beep will be heard every 2 seconds.

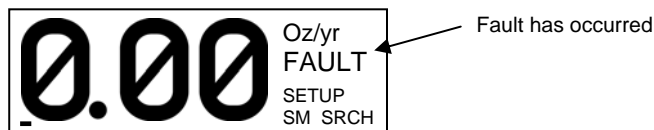

The cause of the fault can be determined by viewing the Diagnostic menu's Last Fault function. To display the Diagnostics menu, first press *both* the **ENT** and **ESC** buttons on either the instrument's front panel or Smart probe at the same time to display the Main menu. Next, use the **Up** and **Down** buttons to highlight "DIAGNOSTICS" and then press **ENT** to display the Diagnostics menu.

Main Menu:

SYSTEM
LOG
SETUPS
CAL DATA
DIAGNOSTICS
FACTORY

Diagnostics Menu:

SENSOR DATA
LAST FAULT
IR EMITTER
PRESSURE
LOOP TEST
CLR LAST FAULT
AUTO GAIN

Select "LAST FAULT" to display the Last Fault screen. Refer to Section 5.1.2 *Last Fault* for a listing of the type of faults that are tracked by the diagnostics, and for information on how to possibly correct the fault. When the cause of the fault has been corrected, the FAULT message and the beep are automatically turned OFF.

4.4 PCHK (atmospheric Pressure Check)

The instrument maintains its accuracy under varying atmospheric conditions by performing an atmospheric pressure check once every hour, or immediately after calibration (refer to Section 2.5.7 *PCHK Mode*.) When a PCHK is performed, the unit beeps once, the pump stops, a valve opens exposing the pressure sensor to the atmosphere, and “PCHK” appears at the bottom-right of the display. During this time the instrument measures the current atmospheric pressure, and then uses this value along with the current temperature and the ideal gas law to compute the gas level. When the pressure check is complete (approximately 5 seconds), the unit beeps, the valve closes, and the pump restarts.

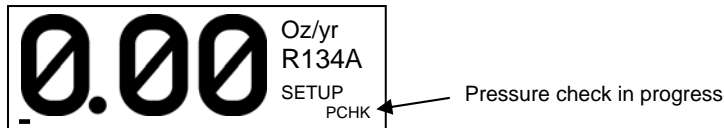

4.5 RS-232 Communication

The RS-232 connector located on the rear of the instrument (refer to Section 1.7.2 *Rear View*) is used to flash the instrument's memory. Refer to Section 5.3 *Flashing Memory*.

Additionally, leak rate data can be output from the port as ASCII text in two formats.

4.6 Serial Output Types

```
<CLOCK
PCHK MODE
SERIAL OUTPUT
<PROBE BUTTON
```

```
SERIAL OUTPUT TYPE
NONE
TEXT PACKET
TEXT ONLY
```

Text Packet

- When TEXT PACKET is selected, a 16 character ASCII string is output approximately 10 times per second. The string is formatted as follows:
<STX> XX.X,-p.pp<ETX>cc
- XX.X is the leak rate as displayed on the front panel, -p.pp is the internal pressure drop in PSI and cc is a two byte checksum.

Text Only

- When TEXT ONLY is selected, a 10 character ASCII string is output approximately 10 times per second.
- The string is formatted as follows:
XX.X,-p.pp <CR><LF>
- XX.X is the leak rate as displayed on the front panel and -p.pp is the internal pressure drop in PSI. CR and LF stand for carriage return and line feed. This option is convenient for capture to file using Hyperterminal or similar software.

Notes:

5 Maintenance

5.1 Diagnostics Menu

The Diagnostics menu provides information about the instrument's operation that will be useful to service technicians for the purpose of troubleshooting various fault conditions.

To display the Diagnostics menu, first press *both* the **ENT** and **ESC** buttons on either the instrument's front panel or Smart probe at the same time to display the Main menu. Next, use the **Up** and **Down** buttons to highlight "DIAGNOSTICS" and then press **ENT** to display the Diagnostics menu.

Main Menu:

SYSTEM
LOG
SETUPS
CAL DATA
DIAGNOSTICS

→ Diagnostics Menu:

SENSOR DATA
LAST FAULT
IR EMITTER
PRESSURE
LOOP TEST
CLR LAST FAULT
AUTO GAIN

5.1.1 Sensor Data

The Sensor Data screen provides information about the sensor's operating parameters and its surrounding environment. When contacting the Bacharach Service Department, the operator may be asked to provide this information to help in the troubleshooting process.

To display the Sensor Data screen, first display the Diagnostics menu as described in Section 5.1. Next, use the **Up** and **Down** buttons to highlight "SENSOR DATA" and then press **ENT**.

Sensor Data Screen Information:

LR Measured Leak Rate
FAULT Current Numerical Fault Code (refer to Section 5.1.2 *Last Fault*)
OPEN/CLOSED Measure / Search Flow Rate Valve Position
DET Detector Voltage
N Detector's Output Noise Factor (with no gas detected)
Z Stored Zero Voltage of Detector
DET Detector Temperature
SPPM PPM Corrected to Standard Pressure and Temperature
BOX Enclosure Temperature
M Manifold Pressure
AMB Ambient Pressure
MPM Moles Per Minute
AU Average Optical Absorbency Unit of Gas being detected (0 = no gas)
PPM Parts Per Million value of the Current Detected Gas Level
UML Absolute Concentration of Gas in Micro Moles per Liter

5.1.2 Last Fault

The Last Fault screen provides a text description of all current faults being detected by the instrument. Once the cause of the fault(s) has been cleared, its description is removed from the screen. The name of the last fault, however, is retained on the screen. This is useful in determining the cause of an intermittent type fault.

To display the Last Fault screen, first display the Diagnostics menu as described in Section 5.1. Next, use the **Up** and **Down** buttons to highlight "LAST FAULT" and then press **ENT**. If necessary, use the **Up** and **Down** buttons to scroll through the fault list. A list of fault messages along with possible causes and remedies for the fault is shown below. The numbers in brackets "< >" are the fault numerical codes that appear on the Diagnostics Sensor Data screen (refer to Section 5.1.1).

TIP: *The Last Fault screen can be cleared of all faults per Section "5.1.6 Clear Last Fault".*

Fault Codes are Additive: The fault codes appearing on the Sensor Data, Diagnostics screen (refer to Section 5.1.1) are additive. For example: A fault code of <0810> indicates that both a Search Flow Fault <0800> and a Loop Open error <0010> have occurred.

Box Temp Error <0001>: Enclosure temperature is high. Check that the enclosure is not being subjected to extreme temperatures. Use the Sensor Data screen to check the box temperature (refer to Section 5.1.1).

Bench Temp Error <0002>: Optical bench temperature is high. Check that the enclosure is not being subjected to extreme temperatures. Use the Sensor Data screen to check the box temperature (refer to Section 5.1.1).

Loop Open <0010>: The 4–20 mA current loop is open, or there is a high resistance in the circuit. Check the wiring to the load/monitoring circuit. If this feature is not being used, a 100 ohm resistor must be connected to the 4–20 mA output connector (refer to Section 2.8).

Internal CAL Error <0020>: An internal calibration failure has occurred. Repeat internal calibration procedure per Section 3.2.

External CAL Error <0040>: An external calibration failure has occurred. Repeat external calibration procedure per Section 3.3.

Digipot Range Error <0200>: The digital potentiometer circuit is out of its normal operating range. Call Bacharach Service with this information for further instructions.

Leak Pressure Fault <0100>: A low pressure condition within the internal leak source has been detected, possibly due to the leak source being out of gas. Check that the box temperature sensor is properly calibrated per Section 5.2.6.3. If leak source is empty, call Bacharach Service.

A/D Failure <0400>: A failure has occurred in the instrument's analog-to-digital circuitry. Call Bacharach Service with this information for further instructions.

Search Flow Fault <0800>: This error occurs in the search mode when the gas flow through the detector has significantly changed. Check that the probe connector is plugged into the instrument, the probe hose is not kinked, and the filter in the probe tip is not clogged. Also check for a blocked internal filter or failed pump.

Measure Flow Fault <1000>: This error occurs in the measure mode when the gas flow through the detector has significantly changed. Check that the probe connector is plugged into the instrument, the probe hose is not kinked, and the filter in the probe tip is not clogged. Also check for a blocked internal filter or failed pump.

No Flow <2000>: Gas flow through the detector has stopped. Check that the probe hose is not kinked, and the filter in the probe tip is not clogged. Also check for a blocked internal filter or failed pump.

Zero Volt Error <4000>: The detector's output voltage may be out of tolerance. Use the Sensor Data screen to check the detector voltage (refer to Section 5.1.1). Call Bacharach Service with this information for further instructions.

A/D Clipping Error <8000>: The detector voltage may be out of tolerance. Use the Sensor Data screen to check the detector voltage (refer to Section 5.1.1). Call Bacharach Service with this information for further instructions.

5.1.3 IR Emitter

The IR Emitter screen provides readouts of the detector's voltage, current, resistance, and power consumption. When contacting the Bacharach Service Department, the operator may be asked to provide this information to help in the troubleshooting process.

To display the IR Emitter screen, first display the Diagnostics menu as described in Section 5.1. Next, use the **Up** and **Down** buttons to highlight "IR EMITTER" and then press **ENT**.

IR EMITTER PARAMETERS	
VOLTS=6.1740	mA=129.5
OHMS=47.7	mW=800.0

5.1.4 Pressure

The Pressure screen provides readouts of bench pressure, ambient pressure, the difference between the two (delta), flow rate through the bench in moles per minute, and the tank pressure of the internal leak source. When contacting the Bacharach Service Department, the operator may be asked to provide this information to help in the troubleshooting process.

To display the Pressure screen, first display the Diagnostics menu as described in Section 5.1. Next, use the **Up** and **Down** buttons to highlight "PRESSURE" and then press **ENT**.

BENCH * AMB	DELT
11.73 14.04	-2.31
FLOW=0.00950Mpm	
LEAK PSI=102.1(100.2)	

This screen also allows a technician to manually turn the pump ON and OFF, along with manually controlling the position of the measure/search flow-rate valve.

Pressing the **Down** button toggles the pump ON and OFF.

Pressing the **Left** button opens and closes the measure/search flow-rate valve. An asterisk (*) on the display indicates that the valve is in its measure position.

5.1.5 Loop Test

The Loop Test screen allows the operator to force the instrument's 4–20 mA loop output to 0, 4, 10, or 20 mA. This function is useful for checking the calibration of external monitoring equipment such as chart recorders.

To display the Loop Test screen, first display the Diagnostics menu as described in Section 5.1. Next, use the **Up** and **Down** buttons to highlight "LOOP TEST" and then press **ENT**.

LOOP TEST	
DOWN=0ma	UP=20ma
LEFT=4ma	RIGHT=10ma
ESC TO QUIT	

Press the **Up**, **Down**, **Left**, and **Right** buttons to produce the desired output current. Press **ESC** to return to the Diagnostics menu.

5.1.6 Clear Last Fault

The Last Fault screen normally displays the last fault detected by the instrument, even if the fault no longer exists. This is useful in determining the cause of an intermittent type fault.

To clear the Last Fault screen of all faults: first display the Diagnostics menu as described in Section 5.1; use the **Up** and **Down** buttons to highlight "CLR LAST FAULT"; press **ENT**; and then confirm this action by pressing the **Up** button.

5.1.7 Auto Gain

```
DIGIPOT=197
IR VOLT=4.2000
```

IMPORTANT! The instrument **must** be sampling fresh air (zero gas) when the Auto Gain function is selected.

Selecting the Auto Gain function automatically sets the IR Detector's voltage to its baseline 0 ppm level by controlling the instrument's digital potentiometer (DIGIPOT) circuit.

5.2 Factory Menu

The Factory menu is used to set up or troubleshoot the instrument. This menu appears only when activated by factory personnel or service technicians who know the correct activation procedure.

When activated, display the Factory menu by first pressing *both* the **ENT** and **ESC** buttons on either the instrument's front panel or Smart probe at the same time to display the Main menu. Next, use the **Up** and **Down** buttons to highlight "FACTORY" and then press **ENT** to display the Factory menu.

Main Menu:

```
SYSTEM
LOG
SETUPS
CAL DATA
DIAGNOSTICS
FACTORY
```

Factory Menu:

```
DIGIPOT
LEAK RATE
LEAK GAS
LEAK TEMP
LEAK TEMPCO
SENSOR CAL
MODEL SELECT
PROBE TYPE
FIRMWARE
```

5.2.1 DIGIPOT

```
DIGIPOT=197
IR VOLT=4.2000
```

IMPORTANT! The instrument **must** be sampling fresh air (zero gas) when adjusting the DIGIPOT value.

The DIGIPOT function allows *manual* and a more precise adjustment of the digital potentiometer, which controls the voltage of the IR Detector. Use the **Up** and **Down** buttons to adjust DIGIPOT value until the IR VOLT reading is 4.200 ±0.0500 volts. Press **ENT** to save the new DIGIPOT value.

5.2.2 Leak Rate

```
LEAK RATE 25.5 g/yr
```

The Leak Rate value is set to match the leak rate of the internal leak source as indicated on the tag attached to the leak source. Use the **Left** and **Right** buttons to move the blinking cursor across the screen to highlight the digit to be modified, and then use the **Up** and **Down** buttons to modify that digit. Press **ENT** to save the new Leak Rate value.

IMPORTANT! Be sure to enter the leak rate using the same units of measure as displayed on the LEAK RATE screen. In this example, the units of measure is g/yr. If your leak source is marked in Oz/yr, then multiply that value by a factor of **28.35**. For example: If the leak source is marked 0.9 Oz/yr, then enter a leak rate of (0.9 x 28.35=) 25.5 g/yr.

5.2.3 Leak Gas

LEAK GAS	< R134A
	R401A
	R402A
	< R402B

The Leak Gas setting is set to match the gas contained in the internal leak source as indicated on the tag attached to the leak source. Use the **Up** and **Down** buttons to highlight the correct gas, and then press **ENT** to select that gas.

5.2.4 Leak Temp

LEAK TEMP	2 3 .9degC
-----------	-------------------

The Leak Temperature value is set to match the temperature of the internal leak source at its time of manufacture as indicated on the tag attached to the leak source. Use the **Left** and **Right** buttons to move the blinking cursor across the screen to highlight the digit to be modified, and then use the **Up** and **Down** buttons to modify that digit. Press **ENT** to save the new Leak Temp value.

5.2.5 Leak TEMPCO

LEAK TEMPCO	0 .54
	%/degC

The Leak Temperature Coefficient value is set to match the temperature coefficient of the internal leak source as indicated on the tag attached to the leak source. Use the **Left** and **Right** buttons to move the blinking cursor across the screen to highlight the digit to be modified, and then use the **Up** and **Down** buttons to modify that digit. Press **ENT** to save the new Leak Temperature Coefficient value.

TIP: To convert a temperature coefficient from % / °F to % °C, multiply the °F value by a factor of **1.8**. For example: $0.3\% / ^\circ F \times 1.8 = 0.54\% / ^\circ C$.

5.2.6 Sensor Cal

PRESSURE
FLOW RATE
BOX TEMP

The Sensor Calibration function allows the service technician to manually calibrate the instrument's Pressure, Flow Rate, and Box Temperature sensors. Use the **Up** and **Down** buttons to highlight the sensor to be calibrated, and then press **ENT** to display that sensor's calibration screen.

5.2.6.1 Pressure Sensor Calibration Screen

ENTER AMBIENT PSIA
1 4 .18
CURRENT OFFSET=0.00

Calibrate the pressure sensor by first measuring the ambient atmospheric pressure using an appropriate pressure measurement device calibrated to read PSIA. Next, adjust the value displayed on the Pressure Sensor Calibration screen to match the measured pressure reading by using the **Left** and **Right** buttons to

move the blinking cursor across the screen to highlight the digit to be modified, and then using the **Up** and **Down** buttons to modify that digit. Press **ENT** to save the new ambient pressure value.

Tip: To convert inHg into PSIA, multiply inHg by 0.491. For example: $30.00 \text{ inHg} \times 0.491 = 14.73 \text{ PSIA}$.

5.2.6.2 Flow Rate Sensor Calibration Screen (Factory Calibration)

S-Mpm/dP	M-Mpm/dP
INT 0.0177/-1.33	0.0100/-2.28
FAC 0.0177/-1.33	0.0100/-2.28
ENTER TO SAVE INT AS FACTORY	

Set the default factory calibration flow and pressure drop values by first performing an internal calibration as described in Section 3.2 *Internal Calibration*.

INT: Flow rate in moles/minute for both the **Search** and **Measure** modes after performing a calibration using the *internal* leak source, along with showing the manifold's pressure drop.

FAC: Flow rate and pressure drop values that are currently stored as the default *factory* calibration values. These values are used to validate calibrations performed by the operator. A calibration error will occur if the operator's calibration and factory values differ by more than 20%.

Press **ENT** to store the internal calibration numbers as factory values. These are the calibration values that are reset when RESTORE FACTORY CAL is selected from the CAL Data menu (refer to Section 3.5 *Restoring Factory Calibration*).

5.2.6.3 Box Temperature Calibration Screen

ENTER BOX TEMP degC
23.41
OFFSET=0.18 LEAK=28.41

In order to accurately determine when the internal leak source is running out of gas, the enclosure's temperature sensor must match the temperature of the leak source, as computed using the pressure/temperature curve for the gas contained in the leak source and the measured pressure of the leak source.

Before making this adjustment, all enclosure lids must be in place and the instrument must be allowed to warm up for at least 30 minutes.

Next, adjust the value displayed on the Box Temperature Calibration screen to match the calculated "LEAK" temperature as displayed in the lower-right corner of the screen. In the example above, set the box temperature for a reading of 28.41 by using the **Left** and **Right** buttons to move the blinking cursor across the screen to highlight the digit to be modified, and then using the **Up** and **Down** buttons to modify that digit. Press **ENT** to save the new box temperature value. Note that the "OFFSET" value is the difference between the box temperature sensor reading, and the box temperature reading adjusted to match the leak source temperature.

5.2.7 Model Select

MODEL SELECT
< 3015-4348 R134A
3015-4464 R600A
< 3015-4465 R600A

The Model Select function is used to set up the instrument's operating characteristics as defined by its Part Number (refer to Appendix "A"). Use the **Up** and **Down** buttons to select the appropriate Part Number (as marked on the instrument's rear panel). Press **ENT** to activate the selection.

5.2.8 Probe Type

```

PROBE TYPE
STD 6ft
STD 12ft
SMART 6 ft
SMART 12 ft

```

Use the Probe Type function to select the probe type that is connected to the instrument. Use the **Up** and **Down** buttons to select the appropriate probe type. Press **ENT** to activate the selection. Refer to Sections 1.7.4, 1.7.5, and 1.7.6 for descriptions of available probe types.

In the example below, a Smart 6 ft probe has been selected. A message is also displayed warning that if the probe type is changed the instrument must be recalibrated, and the new calibration value must be saved as the default factory calibration as described in Section 5.2.6.2.

```

SMART 6ft SELECTED
IF CHANGED, YOU MUST
RESET FACTORY CAL

```

5.2.9 Firmware

```

REV x.xx COMPILED ON
Month Day Year
At hh:mm:ss

```

The Firmware screen displays the firmware's revision number, date, and time of compilation.

5.3 Flashing Memory

As updates to the instrument's firmware become available, the instrument can be upgraded by flashing its memory as described below.

IMPORTANT! *After flashing memory, all operating parameters and sensor calibrations are erased. The operator **must** have access to the Factory menu in order to set up the following parameters before placing the instrument back into operation:*

- DIGIPOT
- Leak rate of internal leak source
- Leak gas of internal leak source
- Leak temperature of internal leak source
- Leak temperature coefficient of internal leak source
- Pressure sensor calibration
- Flow rate sensor calibration
- Box temperature sensor calibration

Items Required:

- 9-pin-Female to 9-pin-Male Serial Cable (P/N 104-4027)
- Flash Utility Software and Latest Firmware Image File (downloaded from Website <http://www.bacharach-inc.com/downloads.htm>)
- Personal computer:
 - Running Windows® 95/98/2000/NT/XP
 - Open COM port

Procedure:

1. Connect one end of a 9-pin female to 9-pin male serial cable to the instrument's rear-panel RS-232 connector.
2. Connect the other end of the cable to and an open COM port connector on the computer (it may be necessary to use a 9-pin to 25-pin adapter to make the computer connection).

NOTE: COM1 is the default port used by the Flash Memory Program. If COM1 is already in use by another device, then connect the instrument to the next available COM port. The software will need to be reconfigured as described in Step 9 to use this port.

- With the instrument turned OFF, set DIP switches 1, 2, and 3 located on the instrument's rear panel to their UP positions.

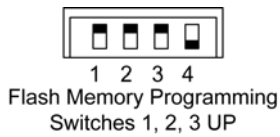

- Turn ON the instrument. Observe that the pump does not start and that the front panel display does not light.

NOTE: The following steps assume that the operator is familiar with the Windows Operating System, and is knowledgeable in creating folders, copying files, and navigating the file system using Windows Explorer. If necessary, refer to the Windows help files for information on performing these operations.

- Create a folder on the computer's hard drive named "C:\RFU" (Rabbit Field Utility).
- Copy the flash utility software and the latest firmware image file (xxx.bin – where "xxx" is the name and version number of the file) into the folder created in Step 5.
- From the C:\RFU folder, run the flash memory program by double clicking the file *rfu.exe*.

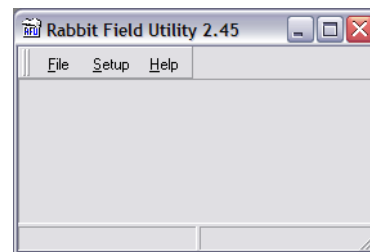

- Select *Setup > Communications*.

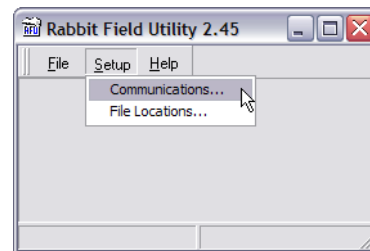

- Under "Serial Options", select *Use Serial Connection*. Then set the Baud Rate to 115200, and select *Enable Processor Detection*.

Note that COM1 is the default Comm Port. If necessary, change the Comm Port to match the port that the instrument was connected to in Step 2.

Click *OK*.

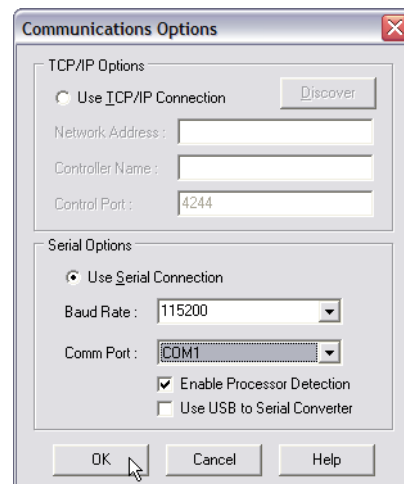

10. Select *Setup > File Locations* and verify that the *coldload.bin*, *pilot.bin*, and *flash.ini* files are all located in the *C:\RFU* folder.

Click *OK* if these files are in the correct folder. If necessary, use the browse buttons in the Choose File Locations dialog box to locate each of these files.

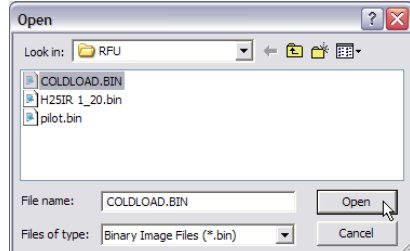
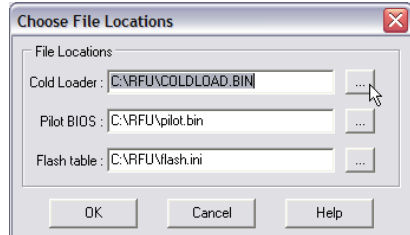
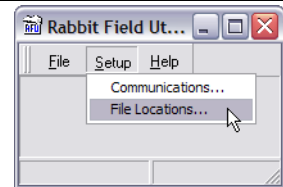

11. Select *File > Load Flash Image*.

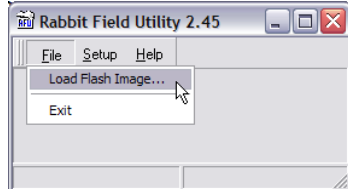

12. Click the browse button in the Choose Flash Image dialog box; navigate to the *C:\RFU* folder; and then highlight the bin file of the new firmware's flash image file. In this example, the file *H25IR_1_20.bin* will be loaded.

Click *Open*.

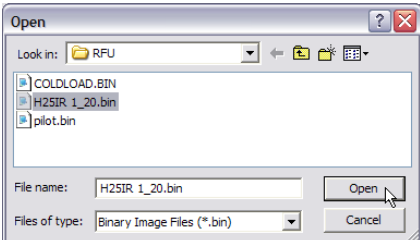
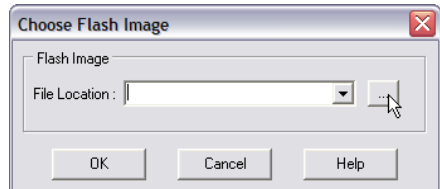

13. Click *OK* to begin the flashing process.

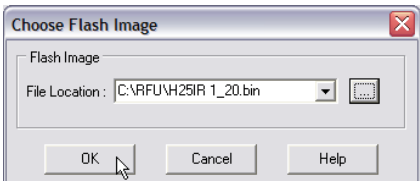

14. A progress-dialog box will appear during the flashing process, and will disappear when the flashing process is complete.

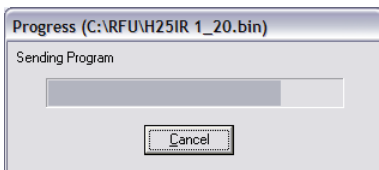

15. When flashing is complete: Exit the flash program; turn OFF the instrument; remove the serial cable; and reset the DIP switches back to their normal operation positions.

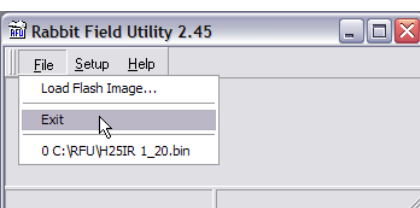
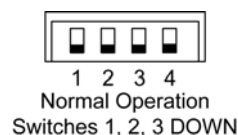

16. Turn ON the instrument. The following message should appear:

FULL SYSTEM RESET!
 SELECT MODEL FROM
 FACTORY MENU AND
 REINIT ALL DATA/CALS

NOTE: *Flashing memory with the same firmware version will not cause the instrument to reset.*

After flashing memory, the instrument will perform a complete system reset, **causing all system parameters and sensor calibration data to be erased!** Complete the flashing process by setting all the parameters contained in the Factory menu (refer to Section 5.2 *Factory Menu*).

5.4 Part Replacement



WARNING! *Shock Hazard. Before performing any service work, remove the AC power cord or battery to prevent electrical shock.*

Part replacement is limited to replacing filters, O-rings, and fuses. It is recommended that all other parts be replaced by an authorized Bacharach Service Center (refer to Section 5.6 *Service Centers*).

5.4.1 Removing the Top Cover

When servicing the parts inside the instrument, the instrument's top cover is removed as follows:

Items Required:

- Medium Phillips head screwdriver

Procedure:

1. Remove both the front and rear bezels by first disengaging the plastic tabs on the right and left sides of the bezel, and then pulling the bezel straight out.
2. Remove the two top screws that secure the front panel.
3. Remove the four screws that secure the rear panel.
4. Remove the Relay, RS-485, and 4–20mA connectors from the rear panel. **DO NOT** remove any connector on the interior side of the rear panel.

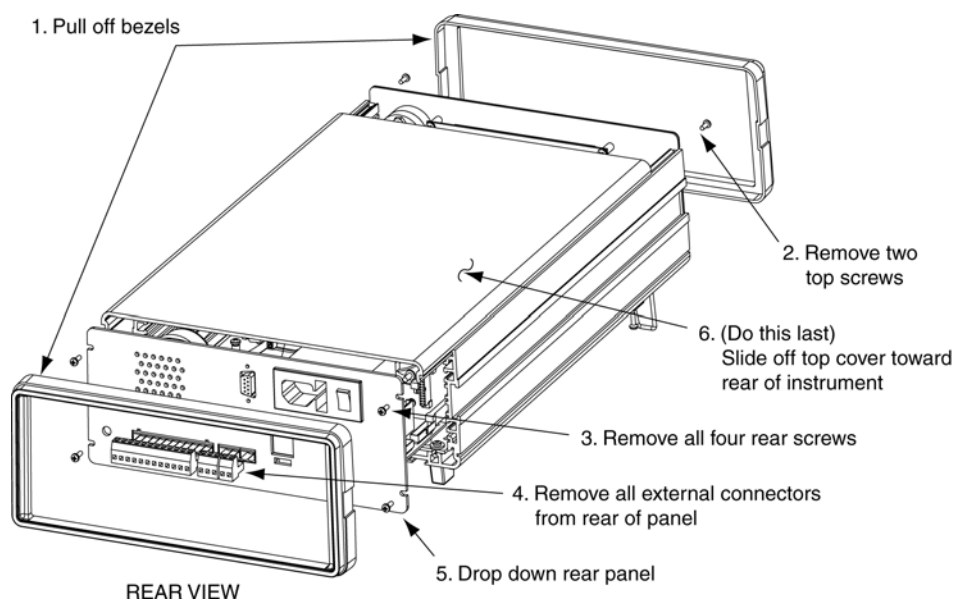

5. Drop down the rear panel far enough to allow the top cover to clear, being careful not to stress the cables attached to the inside of the panel.
6. Remove top cover by sliding it toward rear of instrument.

5.4.2 Fuse Replacement

The H25-IR is protected from electrical damage by a single 1 A fuse located next to the AC receptacle at the rear of the instrument.

Items Required:

- Small flat-blade screwdriver
- Fuse (spare fuse located in fuse holder)

Procedure:

1. Remove AC power cord or battery from instrument.
2. Using a small flat-blade screwdriver, carefully pry the fuse holder out from the fuse compartment.
3. Inspect the fuse for damage or check its continuity. Replace the fuse as necessary.

Use a small flat-blade screwdriver to pry the fuse holder out from the fuse compartment.

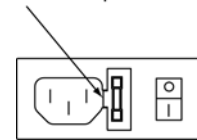

5.4.3 Probe Tip Filter & O-Ring Replacement

A filter located in the probe tip is the instrument's first line of defense against dust, dirt, and moisture from entering the instrument's internal plumbing and IR detector. Replace this filter as it becomes dirty. A clogged filter is identified by a "Search Flow Fault," "Measure Flow Fault," or a "No Flow" fault occurring. Refer to Section 4.3 *Fault*.

Periodically inspect the probe tube's O-ring for signs of cracking. If this O-ring becomes defective, air could be drawn into the instrument through the bottom of the probe tube resulting in inaccurate measurements.

Items Required:

- Probe Tip Filter: Bag of 50: 0.287 in. diameter (7.2 mm)
- Probe Tube O-Ring
- Pin or Tweezers

Procedure:

1. Unscrew probe tip.
2. Pick out old filter with a pin or tweezers.
3. Insert new filter inside probe tip.
4. Replace probe tip.
5. Unscrew probe tube and inspect O-ring. Replace O-ring if defective.
6. Reattach probe tube.

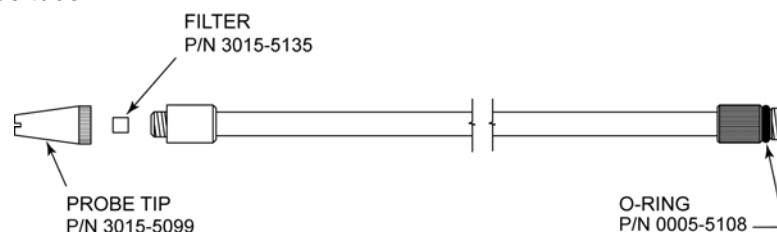

5.4.4 Sprint Switch Replacement

ITEMS REQUIRED:

- Spring Switch Replacement KitP/N 3015-5169
- Loctite
- Screwdriver
- ¼ inch wrench

PROCEDURE:

1. Remove the 4 screws from the front face of the H25-IR case.
2. Disconnect the horizontally placed red connector from the board on the back of the face plate.
3. Using a ¼ inch wrench, unscrew the terminal feed thru. Remove and discard the old spring.
4. Place the supplied nut over the new spring and allow it to slide down until it stops against the terminal feed thru.
5. Spread a small amount of Loctite onto the threads to help secure the spring once it is in place.
6. Insert the spring into the opening.
7. Using a ¼ inch wrench, tighten the terminal feed thru just until the nut makes contact with the opening.
8. Place the red connector into the white fitting on the back of the face plate where the old one was previously removed from.
9. Align the face plate with the instrument and replace the 4 screws into the front of the H25-IR.

5.4.5 Internal Filter Replacement

A filter located inside the instrument may become blocked due to dust or water being drawn into the instrument. A blocked filter is identified by a “Search Flow Fault,” “Measure Flow Fault,” or a “No Flow” fault occurring. Refer to Section 4.3 *Fault*.

Items Required:

- Replacement filter (P/N 3015-4415)
- Medium Phillips head screwdriver

Procedure:

1. Remove the instrument’s top cover as described in Section 5.4.1 *Removing the Top Cover*.
2. Remove the old filter by pulling off the tubing attached to the filter’s inlet and outlet ports.
3. Install the tubing removed in Step 2 onto the new filter.
4. Reassemble the instrument.

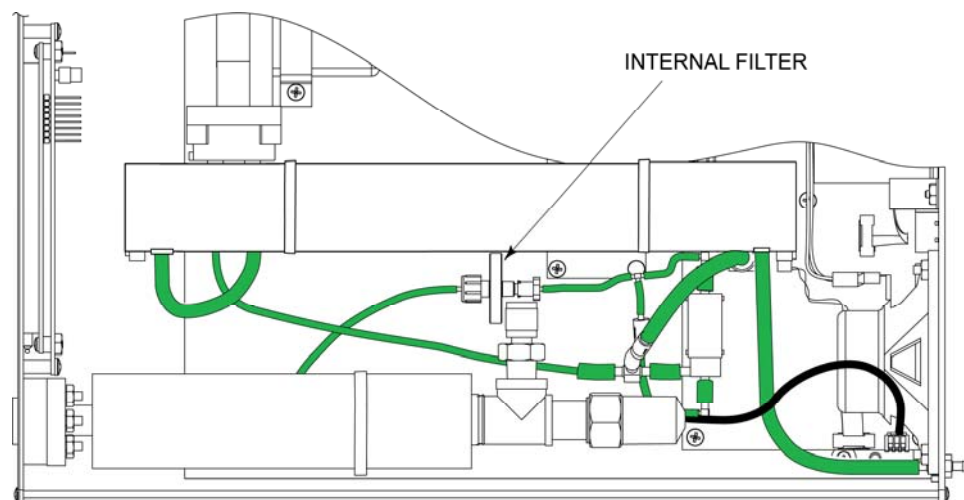

5.4.6 Optical Bench Replacement

These instructions describe how to replace the IR Optical Bench in the H25-IR Infrared Gas Leak Detector.

It is assumed that the user is familiar with the operation and menu system of the H25-IR. If necessary, refer to Instruction 3015-4342 for detailed operation and maintenance information.

Items Required:

- Replacement IR optical bench kit:*

	(800 mW)	(450 mW)
○ CFC, HCFC, HFC & Halogen gases.....	3015-4253	3015-5086
○ R600.....	3015-4453	3015-5089
○ SF ₆	3015-4282	3015-5087
○ CO ₂	3015-4605	3015-5090

- Medium Phillips head screwdriver
- Small flat blade screwdriver
- Wire cutter (for removing cable ties)

* Kit contains IR Bench of gas being detected, cable ties (Qty. 2), and this instruction sheet

5.4.6.1 Top Cover Removal

(See section 5.4.1 *Removing the Top Cover*)

5.4.6.2 Installing the New IR Optical Bench

1. Carefully remove tubing and electrical connectors from old IR bench. See illustration below.
2. Cut off two cable ties that secure IR bench to chassis, and remove bench from instrument.
3. Place new IR bench inside chassis, positioning its 10-pin electrical connector toward the *rear* of the instrument. Rotate the bench so that its gas inlet and outlet fittings and its electrical connectors are positioned as shown in the illustration below.
4. Remove protective caps from the gas inlet and outlet fittings of the new IR bench.
5. Connect the 12-conductor ribbon cable from IR SOURCE connector J5 on main board to IR bench emitter connector (front of instrument).
6. Connect the 10-conductor ribbon cable from DET connector J6 on main board to IR bench detector connector (rear of instrument).
7. Using the two supplied cable ties, secure the IR bench to the chassis by threading each cable tie through its cable-tie mount; around the foam insulation that surrounds the IR bench; and around the 12-conductor ribbon cable. Cut off the cable-tie excess.
8. Connect tubing from pump to the IR bench gas inlet fitting, and connect the IR bench gas outlet fitting to the instrument's exhaust port as shown below.

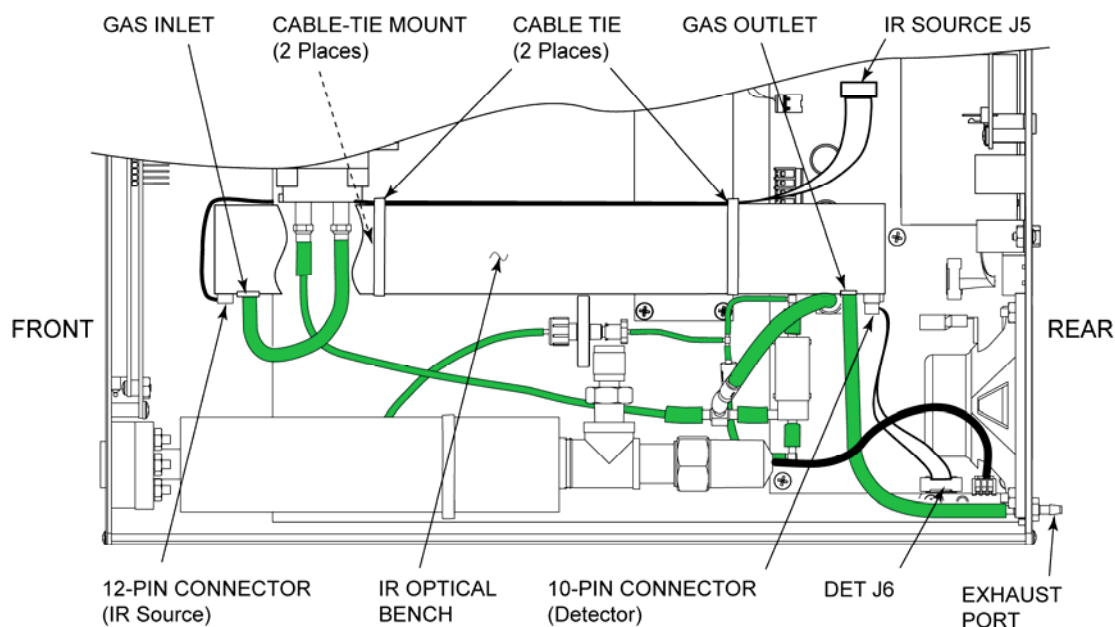

5.4.6.3 IR Emitter Adjustment

WARNING! SHOCK HAZARD. When performing the following step, be careful not to come in contact with AC voltages when working inside the instrument with the cover off and AC voltage applied.

1. Reconnect the AC power cord, and then turn the instrument ON while holding down the front panel **ENT** button to enable the Factory menu
2. Wait until the instrument warms up and the Data Display screen appears before proceeding.

3. Press the **ENT** and **ESC** buttons simultaneously to access the Main menu. From the Main menu, select DIAGNOSTICS > IR EMITTER to display the IR Emitter Parameters screen.
4. Adjust potentiometer R37 located on the main board for an IR Emitter reading of **800 ±20** or **450 ±20 mW**, corresponding to the user's version of part as seen in the items required section containing the part numbers.

IR EMITTER PARAMETERS
VOLTS=5.7345 mA=77.5
OHMS=75.0 mW=450.0

NOTE: Readings for the other parameters on this screen may vary.

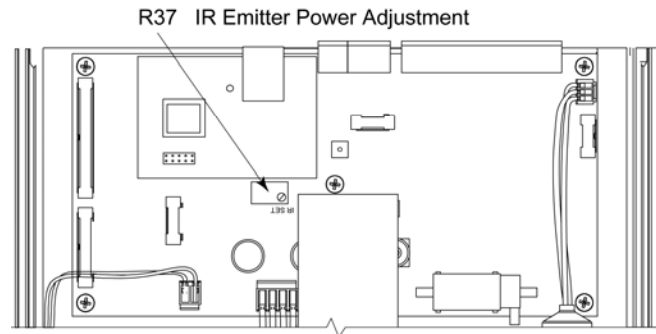

5.4.6.4 DIGIPOT Adjustment

1. Press **ESC** twice to return to the Main menu. From the Main menu, select FACTORY > DIGIPOT to display the DIGIPOT screen.

IMPORTANT! When performing the following Step, the instrument **must** be sampling fresh air (zero gas) when adjusting the DIGIPOT value.

2. Use the **Up** and **Down** buttons to adjust the DIGIPOT value until the IR VOLT reading is 4.2000 ± 0.0500 volts. Press **ENT** to save the new DIGIPOT value.

IMPORTANT! If adjusting the DIGIPOT does not reach 4.2000 ± 0.0500 volts then return to step 18 to lower the IR Emitter setting. IF the IR Emitter setting is 450 ± 20 mW adjust the IR Emitter setting to 375 ± 20 mW. Next, repeat the DIGIPOT adjustment.

DIGIPOT=220
IR VOLT=4.2000

3. Turn OFF instrument and remove AC power cord.
4. Reassemble instrument.

5.4.6.5 Factory Calibration

NOTE: Factory calibration establishes the instrument's default calibration setting that is recalled when "RESTORE FACTORY CAL" is selected from the CAL DATA menu.

1. With all covers in place, turn the instrument back ON while holding down the front panel **ENT** button to enable the Factory menu.

IMPORTANT: Before calibrating, allow the instrument to warm up for at least 15 minutes.

2. Perform an internal calibration as described in the H25-IR instruction manual, 3015-4342.

3. After the instrument has been calibrated, store the flow and pressure calculations of that calibration as the default factory calibration values as follows:
- Press the **ENT** and **ESC** buttons simultaneously to access the Main menu. From the Main menu, select **FACTORY > SENSOR CAL > FLOW RATE** to display the Flow Rate and Pressure screen:

S-Mpm/dP	M-Mpm/dP
INT 0.0177/-1.33	0.0100/-2.28
FAC 0.0177/-1.33	0.0100/-2.28
ENTER TO SAVE INT AS FACTORY	

INT: This line shows the flow rate in moles/minute for both the **S**earch and **M**easure modes after performing a calibration using the internal leak source, along with showing the manifold's pressure drop.

FAC: This line shows the flow rate and pressure drop values that are currently stored as the default factory calibration values. These values are used to validate calibrations performed by the user. A calibration error will occur if the user's calibration and factory values differ by more than 20%.

- Press **ENT** to store the internal calibration numbers as the default factory calibration values.
- Press **ESC** until the Data Display screen appears.

This completes replacing the IR Optical Bench.

5.5 Replacement Parts

Item Description	Part Number
Complete Instrument.....	Refer to Section 1.3 <i>Ordering Information</i>
H25-IR Unit:	
CFC, HCFC, HFC & Halogen gases	3015-4348
R600a	3015-4464
SF ₆	3015-4477
CO ₂	3015-4473
R227	3015-4466
Standard Probe Assembly:	
6 ft (1.8 m) hose.....	3015-4635
12 ft (3.7 m) hose.....	3015-4636
Standard Probe w/ pushbutton and LED Assembly:	
6 ft (1.8 m) hose.....	3015-4639
12 ft (3.7 m) hose.....	3015-4640
Smart Probe w/ pushbuttons and LCD Assembly:	
6 ft (1.8 m) hose.....	19-7113
12 ft (3.7 m) hose.....	19-7114
Flexible Probe Tube Assembly (Stainless Steel)	
Full Assembly - 8 in (203 mm)	3015-5136
Filters – Located in Probe Tip (50).....	3015-5135
Probe Tip.....	3015-5099
O-Ring, Probe Tube.....	0005-5108
Bezel, Case.....	3015-4670
AC Power Cord	304-3459
Battery	0204-0020
Fuse, 1A.....	604-2610
Flexible Probe Tube Assembly (Plastic)	
Filters:	
Located in probe tip:	
Pack of 10	3015-4515
Pack of 50	3015-4516
Located inside instrument.....	3015-4415
Probe Tip.....	3015-4629
Spring Switch Replacement Kit.....	3015-5169

5.6 Service Centers

Service and replacement parts can be obtained by contacting one of the following Bacharach Service Centers:

United States

Bacharach, Inc.
621 Hunt Valley Circle
New Kensington, PA 15068
Phone: 724-334-5051
Fax: 724-334-5723
Email: help@bacharach-inc.com

Canada

Bacharach of Canada, Inc.
250 Shields Court Unit #3
Markham, Ontario L3R 9W7 Canada
Phone: 905-470-8985
Fax: 905-470-8963
Email: bachcan@idirect.com

México

Bacharach de México
Playa Regatas No. 473 Tercer Piso
Col. Militar Marte
Delegación Iztacalco, 08830
México D.F. México
Phones: +52-555-634-7740
 +52-555-634-7741
FAX: +52-555-634-7738
Email: bacharach@prodigy.net.mx

6 Troubleshooting

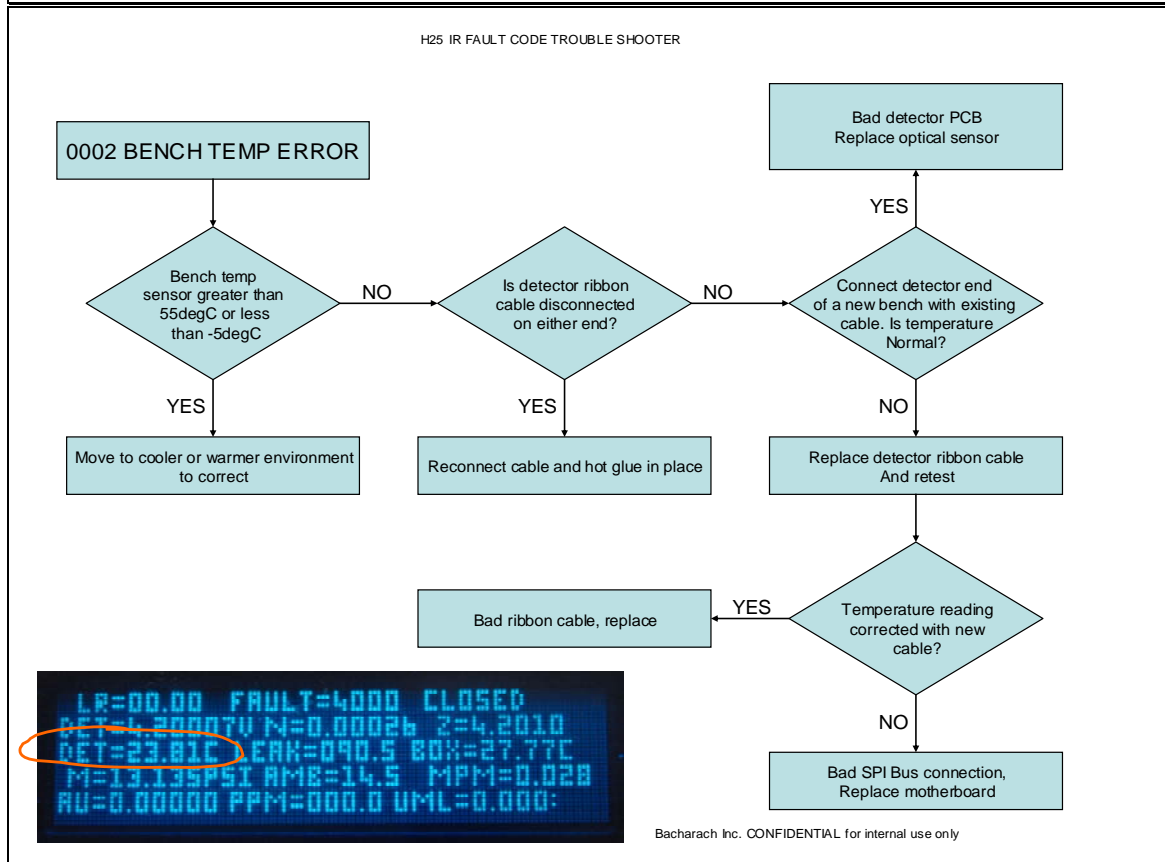
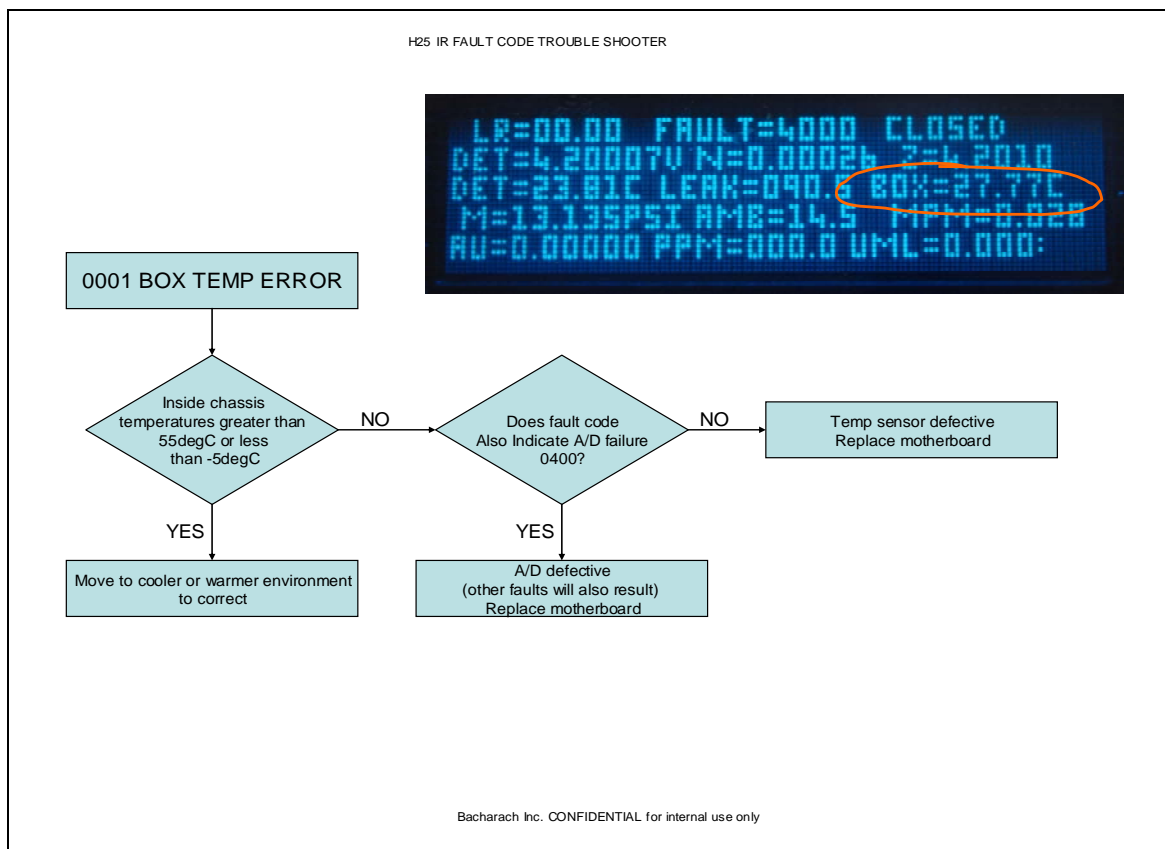

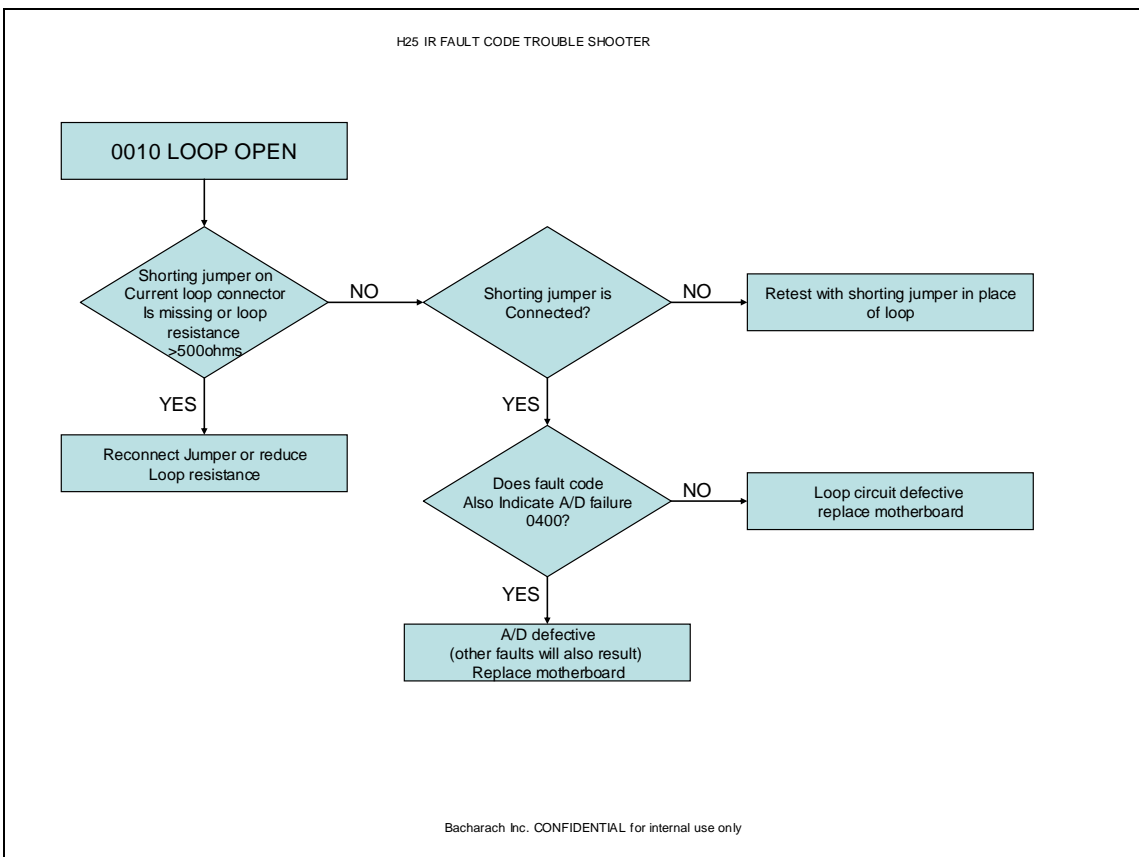
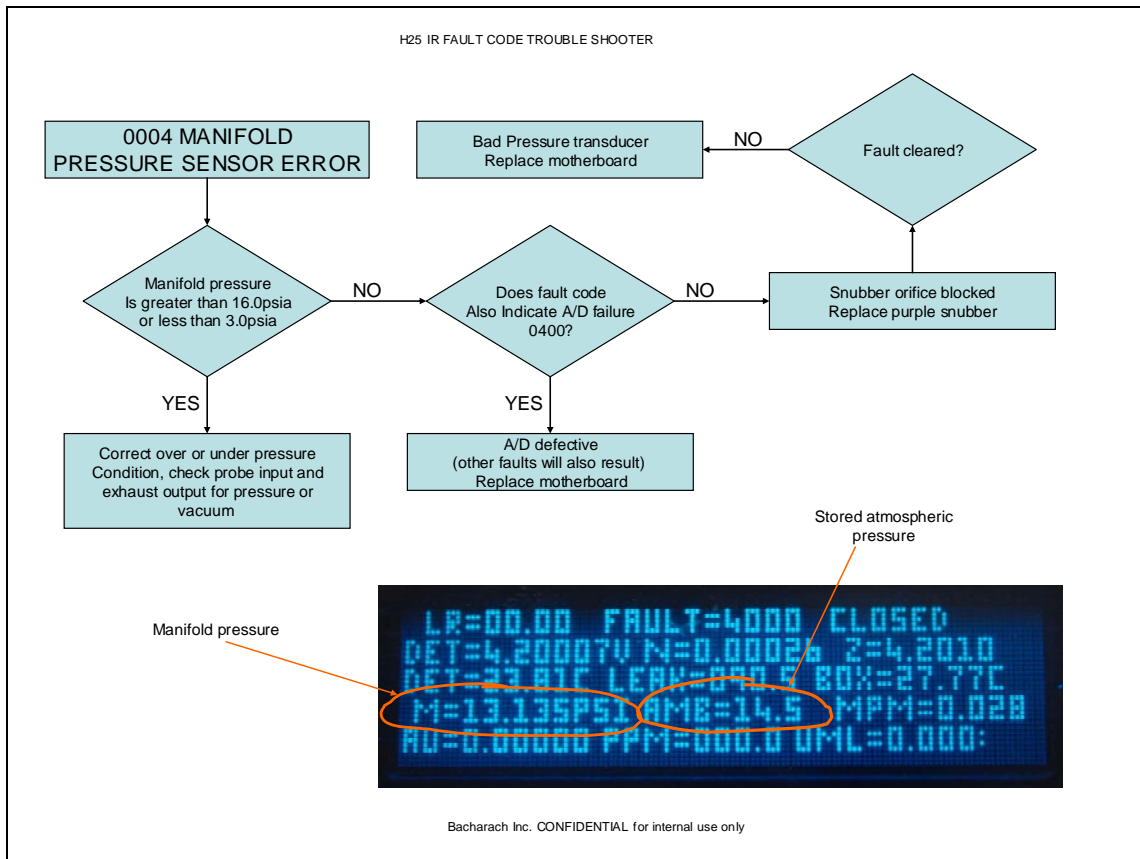

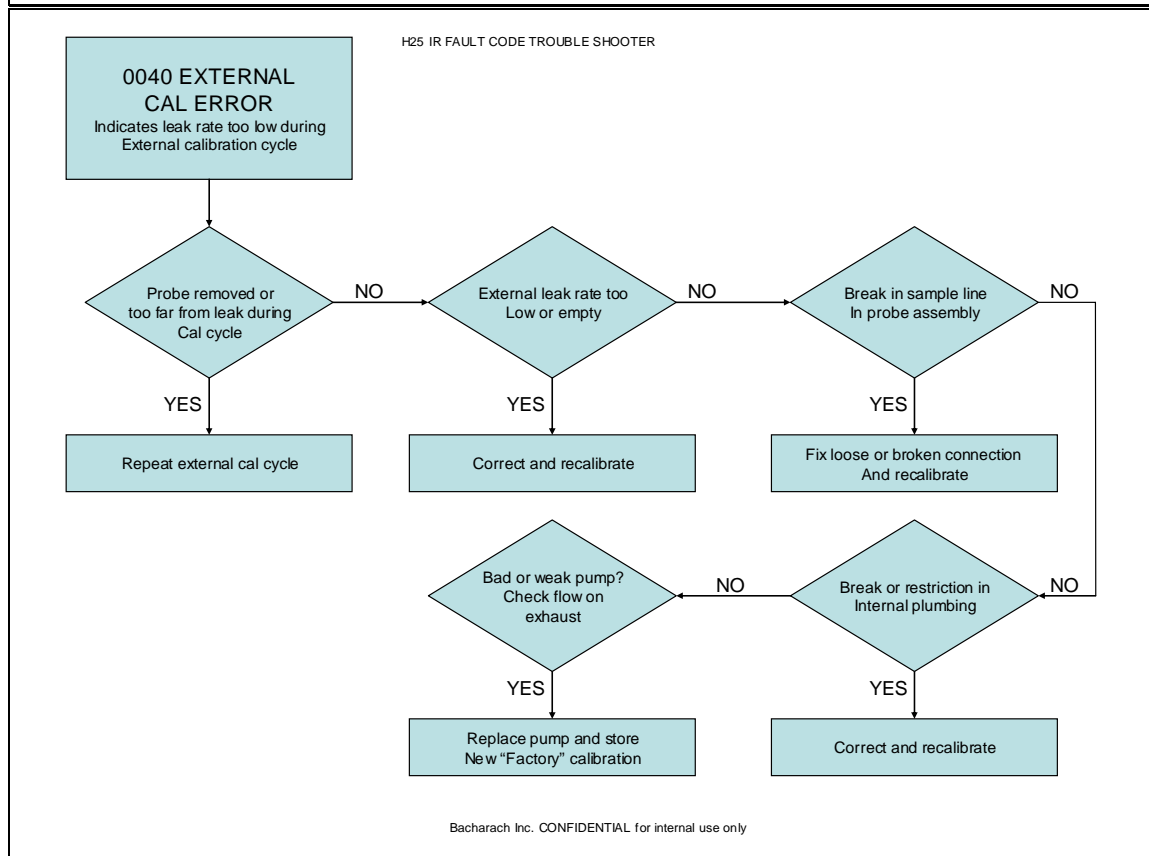
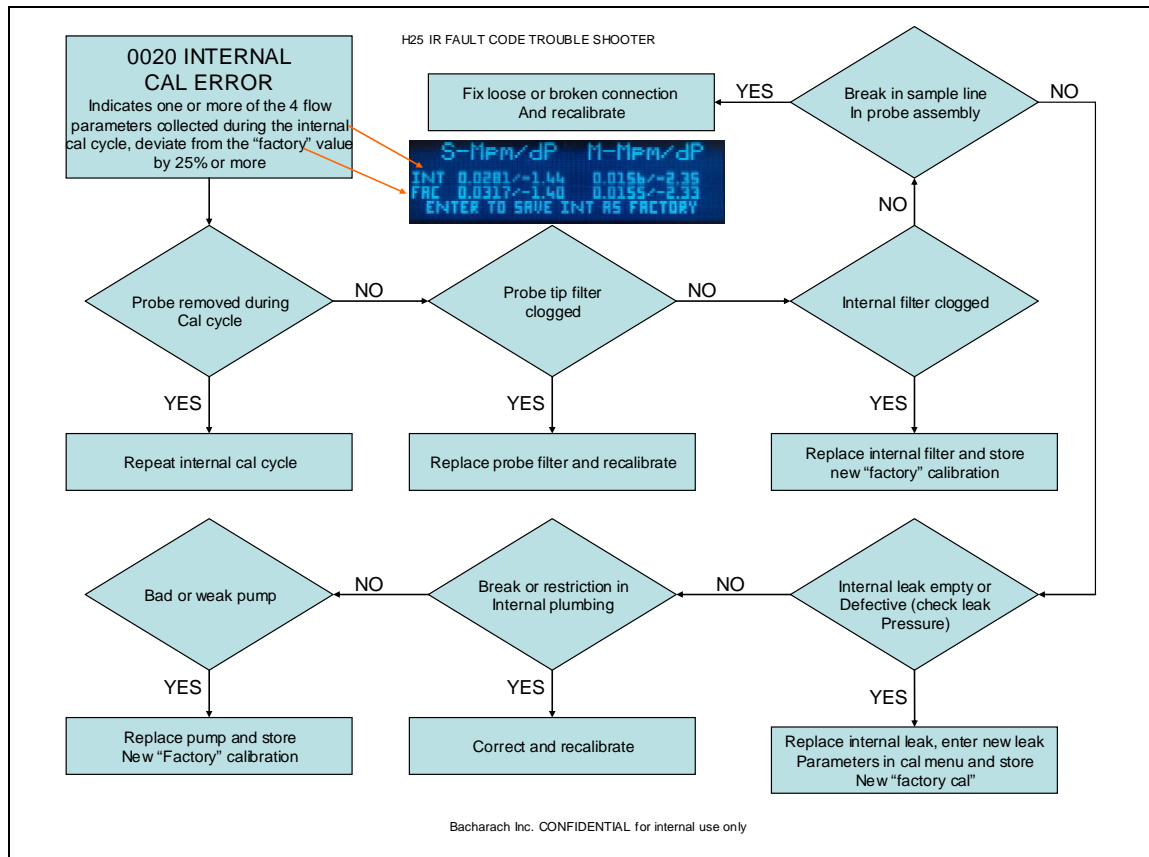

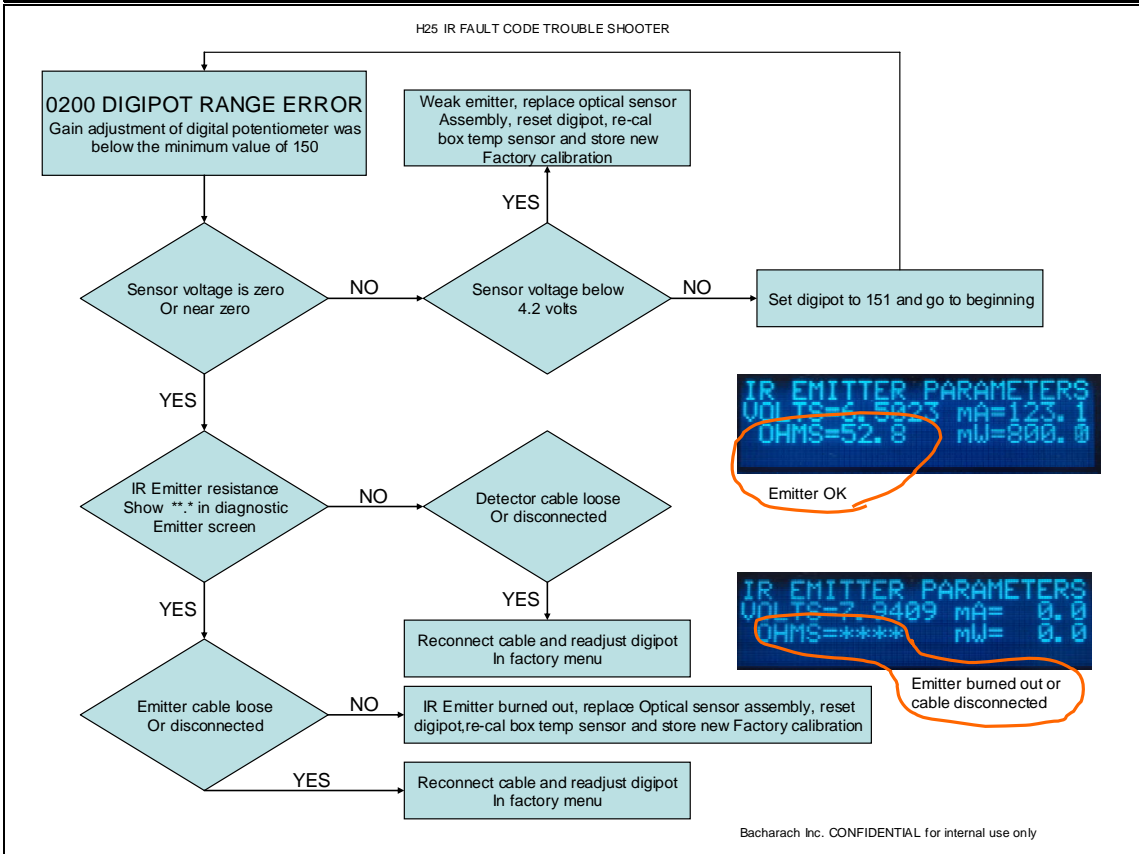
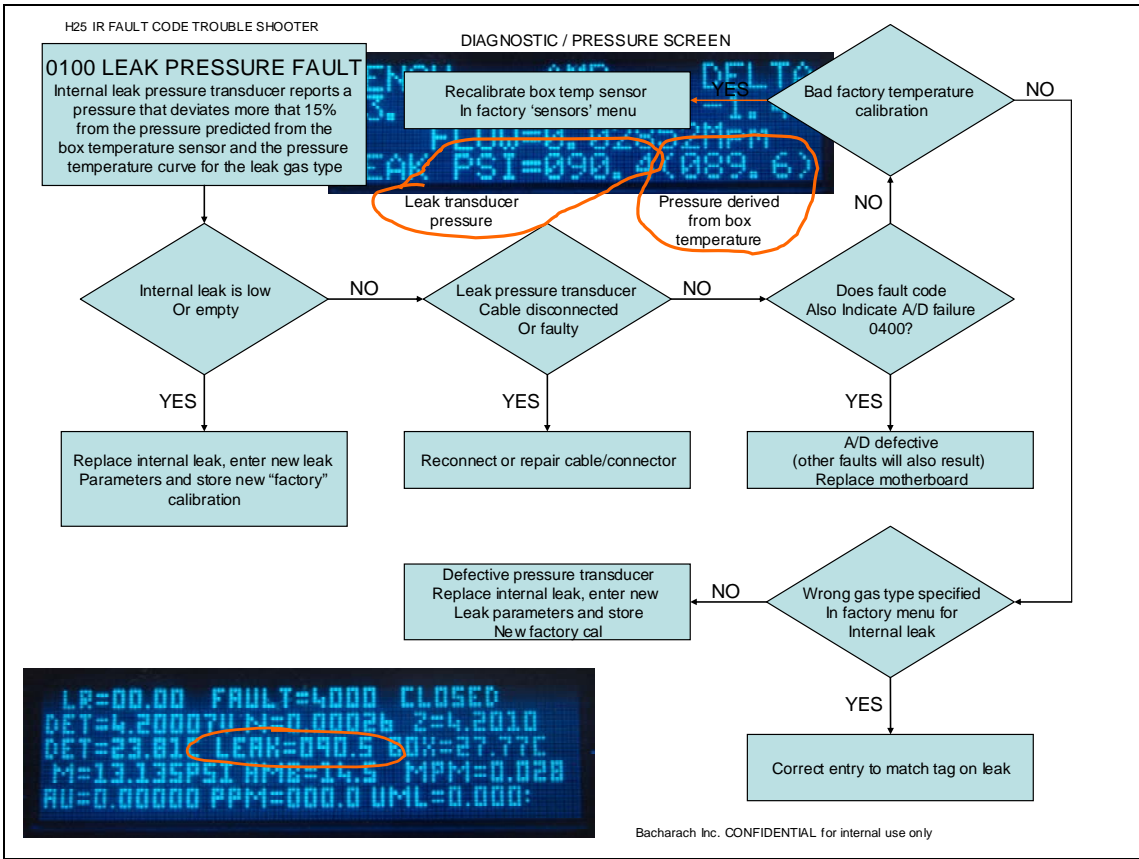

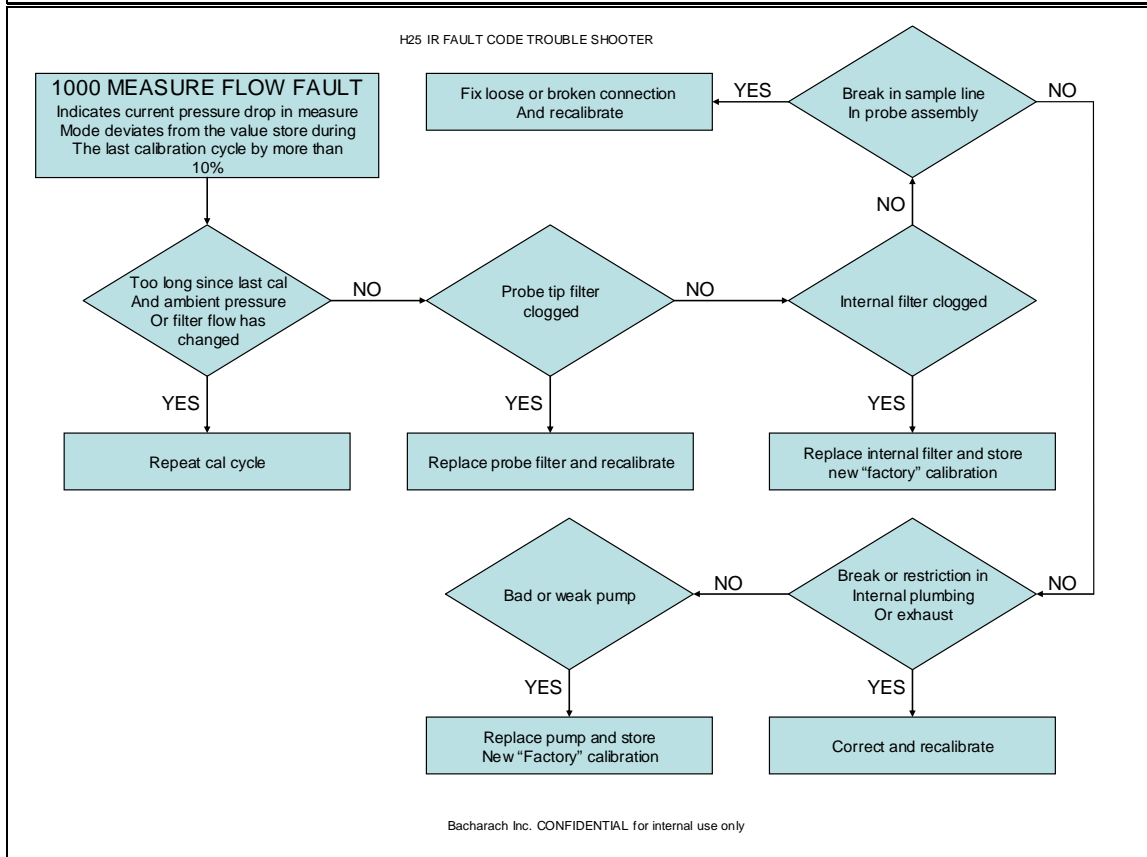
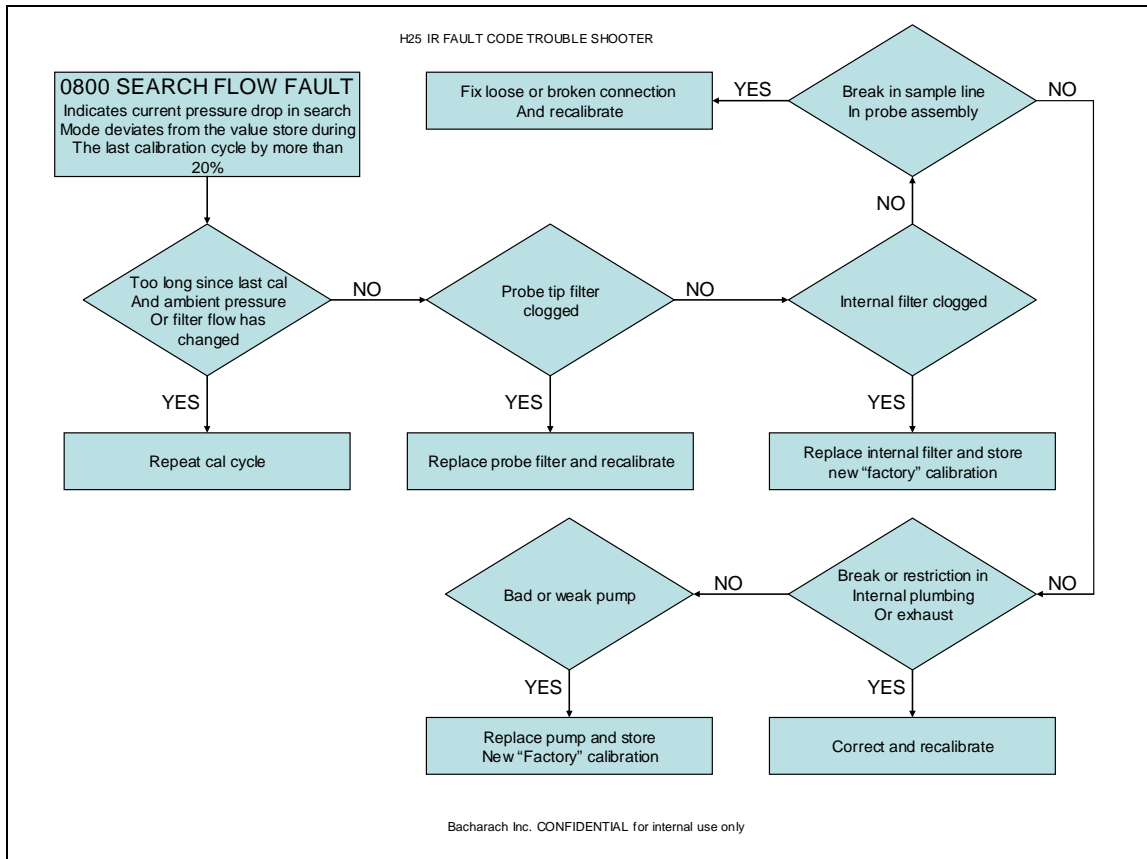

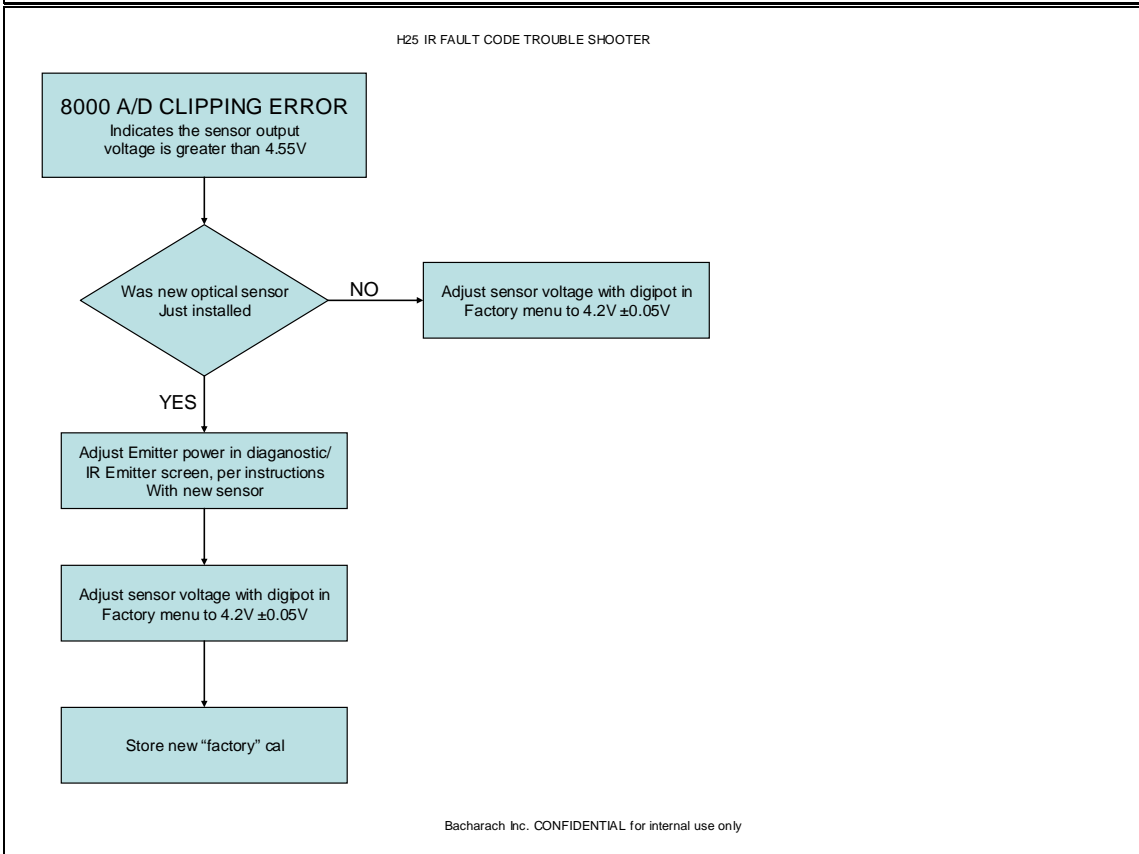
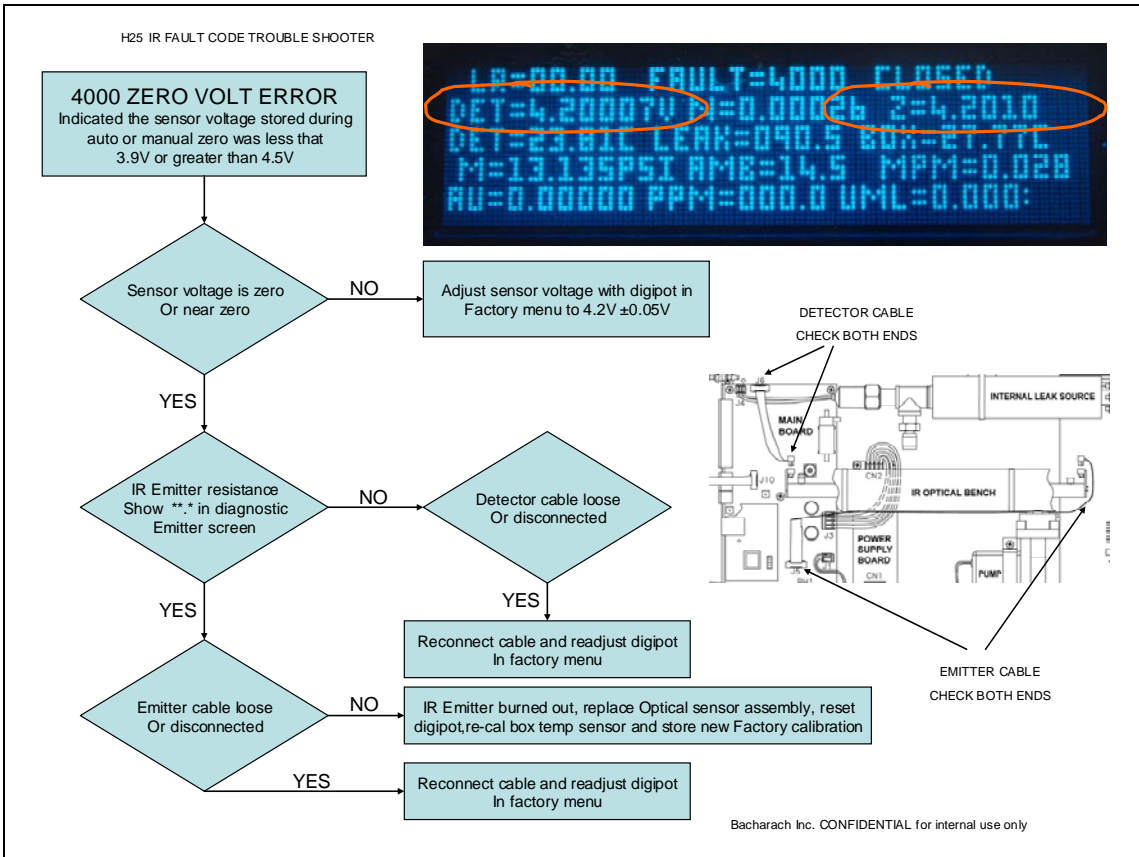

7 Specifications

Gases Detected	Detects and measures, depending on instrument's part number:
	<ul style="list-style-type: none"> • CFCs, HCFCs, HFCs and Halogens R11, R12, R22, R23, R113, R114, R123, R124, R134a, R227, R236fa, R401A, R402A, R402A, R404A, R407A, R407C, R408A, R409A, R410A, R500, R502, R503, R507, R508B, H1211, H1301, H2402, N1230, FA188 • R600a • SF₆ • CO₂ • R227
Detection Method	Infrared
Measurement Units	oz/yr, g/yr, mL/s, PaM ³ /s, ppm
Measurement Range.....	0.03 to 5.00 oz/yr 0.85 to 142 g/yr 0.08 x 10 ⁻⁴ to 100 x 10 ⁻⁴ mL/s 0.08 x 10 ⁻⁵ to 100 x 10 ⁻⁵ PaM ³ /s 0 to 1,000 ppm
Operating Modes.....	Search: detects presence and location of gas leaks Measure: calculates and displays leak rate
Response Time	Up to 3 seconds (dependent on probe-hose length)
Sensitivity	0.03 oz/yr (0.9 g/yr) all gases
Resolution	0.01 oz/yr (0.1 g/yr)
Accuracy:	
Leak Rate	±1% of the accuracy value marked on tag attached to leak source
PPM.....	±10% of reading (can be improved to ±1% if recalibrated using a known concentration of refrigerant gas)
Temperature Drift	±0.8% of reading per °C
Calibration	Internal: calibration performed using the unit's built-in leak source External: calibration performed using a customer supplied leak source of a known gas type and leak rate
Relays	Four SPDT relays (rated 3 A, 240 VAC), each programmable to energize under 11 different operating conditions
Audio Speaker.....	Audible indication of leak level
AC Power	100 to 240 VAC, 50/60 Hz
Battery	16V
Power Consumption.....	15 Watts
Warm-Up Time	2 minutes (30 minutes to meet published specifications)
Operating Temperature.....	32 to 122 °F (0 to 50 °C)
Storage Temperature	-4 to 122 °F (-20 to 50 °C)
Ambient Humidity	5 to 90% RH, non-condensing
Dimensions	4 x 10.75 x 15.5 in. (101.6 x 273.1 x 393.7 mm)
Weight	18 lb (8.2 kg)

Notes:

APPENDIX A – Factory Defaults

Table A-1 lists the factory default parameters that are determined by the instrument's part number (as marked on the rear panel), while Table A-2 lists the default parameters that are user definable.

Table A-1. Default Parameters Defined by Part Number

Part No.	Gas Type	Leak Units	Range	PCHK Mode	Leak Source
3015-4348	R134a*	Oz/yr	Small	Auto	Internal
3015-4434	R600a	g/yr	Small	At CAL	Internal
3015-4448	R134a*	g/yr	Small	At CAL	Internal
3015-4455	R600a	g/yr	Small	At CAL	External
3015-4464	R600a	Oz/yr	Small	Auto	Internal
3015-4465	R600a	Oz/yr	Small	Auto	External
3015-4466	R227	Oz/yr	Small	Auto	Internal
3015-4472	CO ₂	Oz/yr	Small	Auto	External
3015-4473	CO ₂	Oz/yr	Small	Auto	Internal
3015-4475	R134a*	g/yr	Small	At CAL	External
3015-4477	SF ₆	Oz/yr	Small	Auto	Internal
3015-4479	SF ₆	Oz/yr	Small	Auto	External
3015-4482	CO ₂	g/yr	Small	At CAL	External
3015-4483	CO ₂	g/yr	Small	At CAL	Internal
3015-4485	R134a*	Oz/yr	Small	Auto	External
3015-4487	SF ₆	g/yr	Small	At CAL	Internal
3015-4489	SF ₆	g/yr	Small	At CAL	External
3015-4496	R227	Oz/yr	Small	Auto	External
3015-4578	R134a*	g/yr	Small	At CAL	Internal
3015-4588	R600a	g/yr	Small	At CAL	Internal
3015-4589	SF ₆	g/yr	Small	At CAL	Internal
3015-4594	CO ₂	g/yr	Small	At CAL	Internal
3015-4659	R134a*	g/yr	Small	At CAL	External
3015-4660	R600a	g/yr	Small	At CAL	External
3015-4661	SF ₆	g/yr	Small	At CAL	External
3015-4662	CO ₂	g/yr	Small	At CAL	External
3015-4800	SF ₆	mL/s	Small	Auto	Internal

This instrument is capable of detecting CFC, HCFC, HFC and Halogen gases other than R134a. Refer to Section 6 *Troubleshooting* for a complete list of gases.

Table A-2. Default Parameters Defined by User

Parameter	Default Setting
Relays	NOT USED
Loop	0.016 ppm
Setup Name	SETUP NO. 1 SETUP NO. 2 SETUP NO. 3 SETUP NO. 4
Feedback Mode	CONTINUOUS
Setpoint	00.0000
Log Limit.....	999.00

All of the above parameters can be reset to their default settings as described in Section 2.5.9 *Reset Defaults*.

Notes:

Notes:



Headquarters:

621 Hunt Valley Circle, New Kensington, PA 15068

Ph: 724-334-5000 • Fax: 724-334-5001 • Toll Free: 1-800-736-4666

Website: www.bacharach-inc.com • E-mail: help@bacharach-inc.com

Printed in U.S.A.

